

**MAGTROL**

**MODEL 3400**  
**Torque Display**

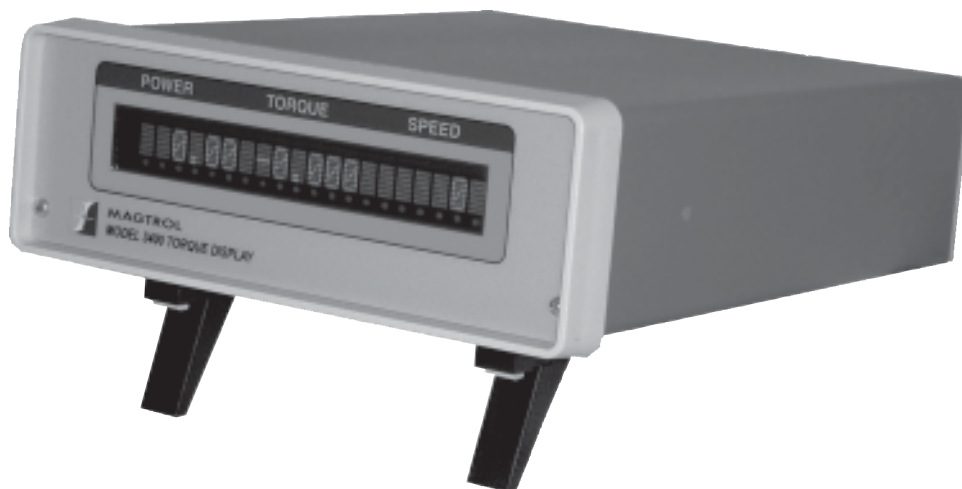

**User's Manual**

---

While every precaution has been exercised in the compilation of this document to ensure the accuracy of its contents, Magtrol, Inc. assumes no responsibility for errors or omissions. Additionally, no liability is assumed for any damages that may result from the use of the information contained within this publication.

#### **COPYRIGHT**

Copyright ©2004 Magtrol, Inc. All rights reserved.

Copying or reproduction of all or any part of the contents of this manual without the express permission of Magtrol is strictly prohibited.

#### **TRADEMARKS**

LabVIEW™ is a trademark of National Instruments Corporation.

National Instruments™ is a trademark of National Instruments Corporation.

Windows® is a registered trademark of Microsoft Corporation.

---

# Safety Precautions

---



1. Make sure that all Magtrol Torque Transducers and electronic products are earth-grounded, to ensure personal safety and proper operation.
2. Make sure that torque transducers and motors under test are equipped with appropriate safety guards.

---

# Revisions To This Manual

---

The contents of this manual are subject to change without prior notice. Should revisions be necessary, updates to all Magtrol User's Manuals can be found at Magtrol's web site at [www.magtrol.com/support/manuals.htm](http://www.magtrol.com/support/manuals.htm).

Please compare the date of this manual with the revision date on the web site, then refer to the manual's Table of Revisions for any changes/updates that have been made since this edition.

## REVISION DATE

1st Edition, Revision A – January 2004

## TABLE OF REVISIONS

Date	Edition	Change	Section(s)
01/09/04	1st Edition, rev. A	Increased options to include TM 300 series torque transducers.	4.1.1
01/09/04	1st Edition, rev. A	Added one more press of SYSTEM button to step #3.	4.1.1
01/09/04	1st Edition, rev. A	Added Encoder Selection section.	4.1.2
01/09/04	1st Edition, rev. A	Added one more press of SYSTEM button to step #1.	4.1.4 – 4.1.6
01/09/04	1st Edition, rev. A	Added BITE command to list of setup commands.	5.2.2

---

# Table of Contents

---

<b>SAFETY PRECAUTIONS .....</b>	<b>i</b>
<b>REVISIONS TO THIS MANUAL .....</b>	<b>ii</b>
REVISION DATE .....	ii
TABLE OF REVISIONS .....	ii
<b>TABLE OF CONTENTS .....</b>	<b>iii</b>
<b>PREFACE .....</b>	<b>vi</b>
PURPOSE OF THIS MANUAL .....	vi
WHO SHOULD USE THIS MANUAL .....	vi
MANUAL ORGANIZATION .....	vi
CONVENTIONS USED IN THIS MANUAL .....	vii
<b>1. INTRODUCTION .....</b>	<b>1</b>
1.1 UNPACKING YOUR 3400 TORQUE DISPLAY .....	1
1.2 FEATURES OF THE 3400 TORQUE DISPLAY .....	1
1.3 DATA SHEET .....	2
<b>2. CONTROLS .....</b>	<b>4</b>
2.1 FRONT PANEL .....	4
2.2 REAR PANEL .....	5
2.2.1 Rear Panel Inputs and Outputs .....	5
2.2.2 Rear Panel Controls and Buttons .....	6
<b>3. INSTALLATION/CONFIGURATION .....</b>	<b>7</b>
3.1 POWERING UP THE 3400 .....	7
3.1.1 Line Voltage .....	7
3.1.2 Self-Test .....	7
3.1.3 Main Menu .....	8
<b>4. MANUALLY CONTROLLED OPERATION .....</b>	<b>9</b>
4.1 SETTING DESIRED OPERATING PARAMETERS .....	9
4.1.1 Model Setup .....	9
4.1.2 Encoder Selection .....	10
4.1.3 Torque Units Setup .....	10
4.1.4 Power Units Setup .....	10
4.1.5 Contrast Setup .....	11
4.1.6 System Setup Check .....	11
4.1.7 Tare Function .....	12
4.1.8 BITE Function .....	12
<b>5. COMPUTER CONTROLLED OPERATION .....</b>	<b>13</b>
5.1 ABOUT THE RS-232 INTERFACE .....	13
5.1.1 Connection .....	13
5.1.2 Communication Parameters .....	13
5.2 3400 COMMAND SET .....	14
5.2.1 Communication Commands .....	14
5.2.2 Setup Commands .....	14
5.2.3 Calibration Commands .....	15

---

<b>6. CALIBRATION .....</b>	<b>16</b>
6.1 CLOSED-BOX CALIBRATION .....	16
6.2 CALIBRATION SCHEDULE .....	16
6.3 BASIC CALIBRATION PROCESS .....	16
6.3.1 Initial Calibration Procedure .....	16
6.3.2 Torque Offset and Gain .....	16
<b>7. TROUBLESHOOTING .....</b>	<b>17</b>
<b>APPENDIX A: SCHEMATICS .....</b>	<b>18</b>
A.1 78P205 BOARD .....	18
<b>GLOSSARY .....</b>	<b>19</b>
<b>INDEX .....</b>	<b>20</b>
<b>MAGTROL LIMITED WARRANTY .....</b>	<b>21</b>
CLAIMS .....	21

---

## TABLE OF FIGURES

CHAPTER 2	
Figure 2-1	Front Panel ..... 4
Figure 2-2	Rear Panel ..... 5
Figure 2-3	Transducer Connector ..... 5
Figure 2-4	RS-232C Interface ..... 5
CHAPTER 3	
Figure 3-1	Cable and Connection Diagrams ..... 7
Figure 3-2	Title Display ..... 8
Figure 3-3	Revision Display ..... 8
Figure 3-4	Main Menu ..... 8
CHAPTER 4	
Figure 4-1	System Display ..... 9
Figure 4-2	Model Setup Menu ..... 9
Figure 4-3	Saving System Display ..... 9
Figure 4-4	Torque Units Setup Menu ..... 10
Figure 4-5	Power Units Setup Menu ..... 10
Figure 4-6	Contrast Setup Menu ..... 10
Figure 4-7	System Check Display Example ..... 11
Figure 4-8	BITE Display ..... 12
CHAPTER 5	
Figure 5-1	RS-232 Interface ..... 13
Figure 5-2	Cable Connection ..... 13

---

# Preface

---

## PURPOSE OF THIS MANUAL

This manual contains all the information required for the installation and general use of the Model 3400 Torque Display. To achieve maximum capability and ensure proper use of the instrument, please read this manual in its entirety before operating. Keep the manual in a safe place for quick reference whenever a question should arise.

## WHO SHOULD USE THIS MANUAL

This manual is intended for bench test operators who are going to use the 3400 Torque Display in conjunction with any Magtrol In-Line Torque Transducer.

## MANUAL ORGANIZATION

This section gives an overview of the structure of the manual and the information contained within it. Some information has been deliberately repeated in different sections of the document to minimize cross-referencing and to facilitate understanding through reiteration.

The structure of the manual is as follows:

- Chapter 1: INTRODUCTION - Contains the technical data sheet for the 3400 Torque Transducer Display, which describes the unit and provides its mechanical and electrical characteristics.
- Chapter 2: CONTROLS - Description of the elements located on the front and rear panels of the unit.
- Chapter 3: INSTALLATION/CONFIGURATION - Provides information needed for setup of the 3400.
- Chapter 4: MANUALLY CONTROLLED OPERATION - How to run a test when the 3400 is used as a stand-alone unit.
- Chapter 5: COMPUTER CONTROLLED OPERATION - How to run a test when the 3400 is used with a personal computer. Includes information on serial (RS-232) interface and command set.
- Chapter 6: CALIBRATION - Provides recommended calibration schedules along with step-by-step instructions for the calibration procedure.
- Chapter 7: TROUBLESHOOTING - Solutions to common problems encountered during setup and testing.
- Appendix A: SCHEMATICS - For the analog section.
- Glossary: List of abbreviations and terms used in this manual, along with their definitions.



## CONVENTIONS USED IN THIS MANUAL

The following symbols and type styles may be used in this manual to highlight certain parts of the text:



---

**Note:** This is intended to draw the operator's attention to complementary information or advice relating to the subject being treated. It introduces information enabling the correct and optimal functioning of the product to be obtained.

---



---

**CAUTION:** THIS IS USED TO DRAW THE OPERATOR'S ATTENTION TO INFORMATION, DIRECTIVES, PROCEDURES, ETC. WHICH, IF IGNORED, MAY RESULT IN DAMAGE BEING CAUSED TO THE MATERIAL BEING USED. THE ASSOCIATED TEXT DESCRIBES THE NECESSARY PRECAUTIONS TO TAKE AND THE CONSEQUENCES THAT MAY ARISE IF THE PRECAUTIONS ARE IGNORED.

---



---

**WARNING!** THIS INTRODUCES DIRECTIVES, PROCEDURES, PRECAUTIONARY MEASURES, ETC. WHICH MUST BE EXECUTED OR FOLLOWED WITH THE UTMOST CARE AND ATTENTION, OTHERWISE THE PERSONAL SAFETY OF THE OPERATOR OR THIRD PARTY MAY BE PUT AT RISK. THE READER MUST ABSOLUTELY TAKE NOTE OF THE ACCOMPANYING TEXT, AND ACT UPON IT, BEFORE PROCEEDING FURTHER.

---

# 1. Introduction

## 1.1 UNPACKING YOUR 3400 TORQUE DISPLAY

Your 3400 Torque Display was packaged in reusable, shock resistant packing material that will protect the instrument during normal handling.

1. Make sure the carton contains the following:

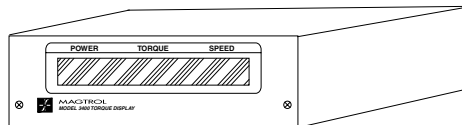

3400 Torque Display

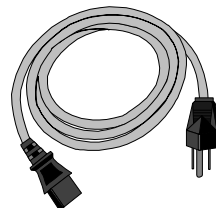

Line cord

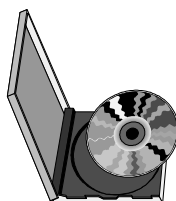

Magtrol  
User Manual  
CD-Rom

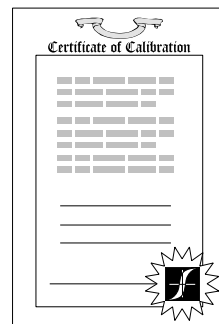

Calibration Certificate

2. Inspect the contents for any evidence of damage in shipping. In the event of shipping damage, immediately notify the carrier and Magtrol's Customer Service Department.



Note: Save all shipping cartons and packaging material for reuse when returning the instrument for calibration or servicing.

## 1.2 FEATURES OF THE 3400 TORQUE DISPLAY

Designed specifically for use with Magtrol's In-Line Torque Transducers, the new Model 3400 Torque Display powers the transducer and utilizes high speed digital signal processing to display torque, speed and mechanical power. Its features include:

- **High Quality, Easy-to-Read Display:** Vacuum fluorescent readout.
- **Isolated RS-232 Interface:** Eliminates system ground loops.
- **Torque Measurement Options:** Standard English, metric and SI settings.
- **Closed-Box Calibration of Torque:** Eliminates need to open box for adjustments.

**1.3 DATA SHEET**

# Model 3400 Torque Display

## FEATURES

- For use with all Magtrol TM, TMHS and TMB Torque Transducers
- BITE: Built-In Test Equipment
- Isolated RS-232 Interface
- High Quality, Easy-to-Read Vacuum Fluorescent Readout: Displays torque, speed and power
- Torque Measurement Options: Standard English, metric and SI settings
- Overload Indication
- Tare Function
- Closed Box Calibration
- Free LabVIEW™ Data Acquisition Software: Provides complete remote control of the 3400 Torque Display and enables the user to view/print/save torque, speed and power data via a personal computer



## DESCRIPTION

Magtrol’s NEW Model 3400 Torque Display is designed for use with all TM, TMHS and TMB Torque Transducers. This easy-to-use device powers the transducer and utilizes high speed Digital Signal Processing (DSP) to display torque, speed and mechanical power. It includes a tare function to help offset

any slight residuals caused by couplings or suspended loads. The 3400 may also be used with sensors requiring 24 VDC power (220 mA max.) and have  $\pm 5$  VDC torque output ( $\pm 10$  VDC max.) and open collector/TTL speed outputs.

## SYSTEM CONFIGURATION

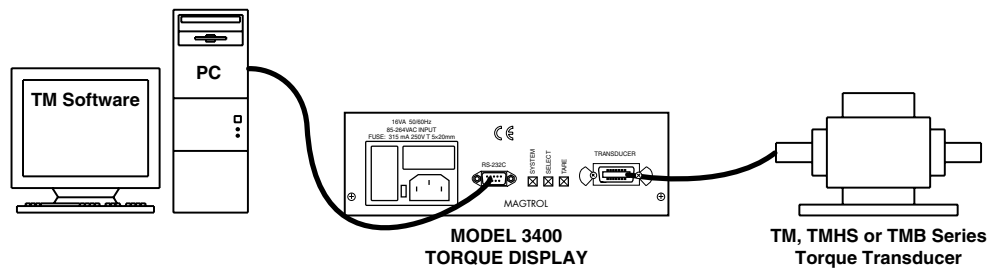

# Specifications

3400

Dimensions (inches)	9.88 W x 7.49 D x 2.8 H
Dimensions (mm)	251.0 W x 190.2 D x 71.3 H
Weight	2.85 lbs / 1.28 kg
Operating Temperature	5°C to 40°C
Relative Humidity	< 80%
Accuracy	Speed: 0.01% of reading from 10 rpm to 100,000 rpm Torque: 0.01% of range ( $\pm 5$ V)
Temperature Coefficient	0.001% (5°C to 50°C) of FS/°C
Fuses (5 x 20 mm)	315 mA IEC 250 V T
Power Requirements	16 VA
Voltage Requirements	120/240 V 60/50 Hz
Maximum Speed/Input Frequency	99,999 rpm/50,000 Hz
Maximum Voltage (Torque Input)	$\pm 10$ VDC

## FRONT PANEL

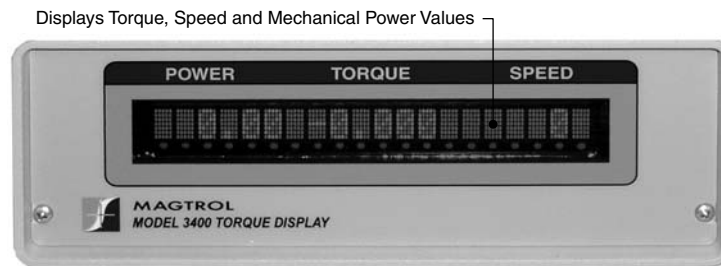

## REAR PANEL

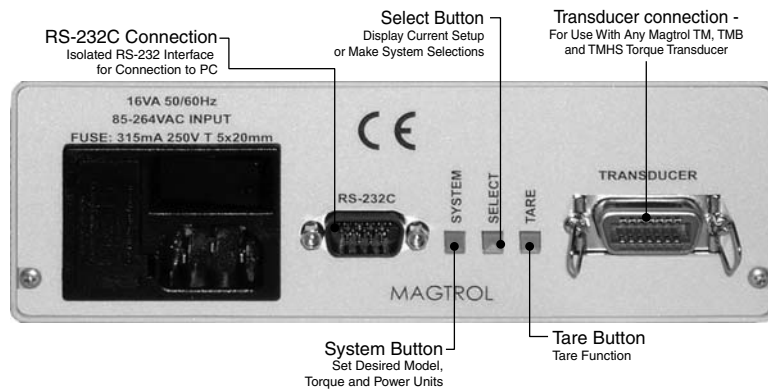

## ACCESSORIES

Description	Model/Part #
Torque Transducer Connector Cable, 5 m	ER 113-01
Torque Transducer Connector Cable, 10 m	ER 113-02
Torque Transducer Connector Cable, 20m	ER 113-03

*Due to the continual development of our products, we reserve the right to modify specifications without forewarning.*

## 2. Controls

### 2.1 FRONT PANEL

The front panel contains a Vacuum Fluorescent Display (VFD) that provides information about the control functions and torque transducer.

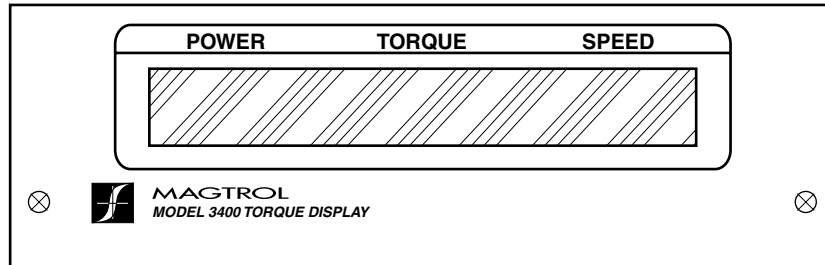

Figure 2-1 Front Panel

The displays from left to right are:

- POWER
- TORQUE
- SPEED
- Overload Indicator: If the inputs exceed the range of the instrument, "-OL-" will appear in the TORQUE or SPEED portion of the display. Once the condition has cleared, the unit will automatically return to the main menu.

## 2.2 REAR PANEL

The rear panel provides connectors and receptacles for connecting to appropriate equipment along with a power switch and 3 control buttons.

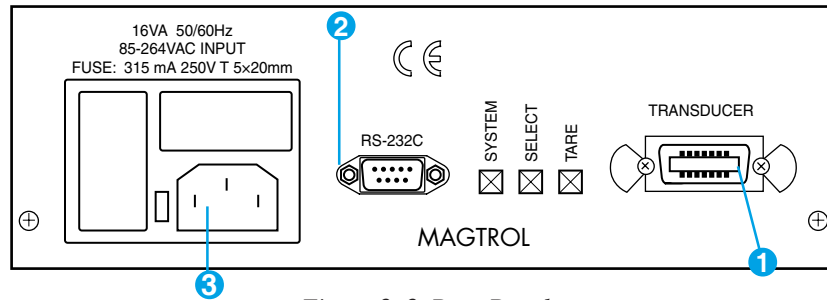
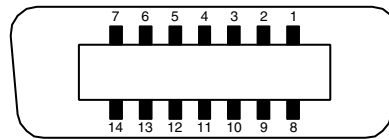

Figure 2–2 Rear Panel

### 2.2.1 REAR PANEL INPUTS AND OUTPUTS

- 1** TRANSDUCER CONNECTOR      Connect transducer signal cable here.



- |                |                         |
|----------------|-------------------------|
| 1. N/C         | 8. N/C                  |
| 2. N/C         | 9. ROTATIONAL DIRECTION |
| 3. +24 VDC     | 10. SPEED               |
| 4. +24 VDC COM | 11. N/C                 |
| 5. +24 VDC COM | 12. BITE                |
| 6. N/C         | 13. TORQUE COMMON       |
| 7. N/C         | 14. TORQUE SIGNAL       |

Figure 2–3 Transducer Connector

- 2** RS-232C      Isolated RS-232 connector.

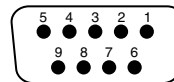

- |        |    |
|--------|----|
| 1.     | 6. |
| 2. RX  | 7. |
| 3. TX  | 8. |
| 4.     | 9. |
| 5. GND |    |

Figure 2–4 RS-232C Interface

- 3** POWER      Attach IEC approved power cord here.

## 2.2.2 REAR PANEL CONTROLS AND BUTTONS

The rear panel controls and buttons, from left to right, are:

- Power switch
- System button
- Select button
- Tare button

The following table provides a quick reference on how to use each button. For more detailed information refer to *Chapter 4 – Manually Controlled Operation*.

Button	To Use	Function
POWER	Press I to turn power ON. Press O to turn power OFF.	Turns power ON or OFF.
SYSTEM	Press.	Enables setup of model, torque units, power units and display contrast settings.
SELECT	During SYSTEM setup, press and release. During normal operation, press and hold button.	During SYSTEM setup, scrolls through available model, torque unit, power unit and display contrast setting options. During normal operation, displays current setup.
TARE	Press.	Sets the current A/D reading as the offset value during calculations.

# 3. Installation/Configuration



Note: Before installing the 3400, you should become familiar with the front and rear panels, as outlined in *Chapter 2—Controls*.

## 3.1 POWERING UP THE 3400



Note: To reduce the risk of electric shock, the case of the 3400 is earth grounded.

### 3.1.1 LINE VOLTAGE

The 3400 will operate with either of the following power sources without any modifications:

- 120 V 50/60 Hz
- 240 V 50/60 Hz

### 3.1.2 SELF-TEST



Note: To make sure that the 3400 is operational, a Magtrol torque sensor must be installed and connected to the 3400.

1. Connect the 3400 to the torque transducer using a 14-pin to 6-pin signal cable.

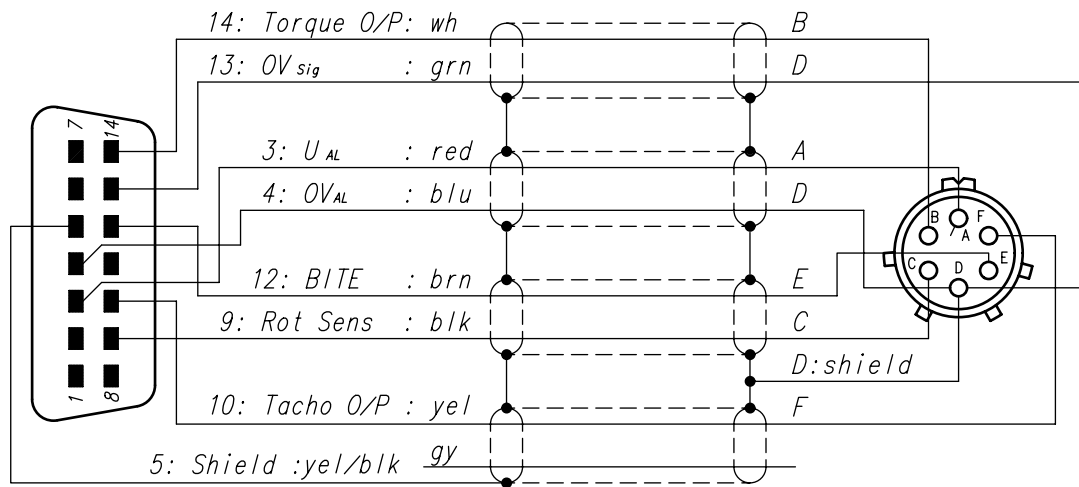

Figure 3-1 Cable and Connection Diagrams



2. Turn on the power to the 3400. The Title Display will appear.

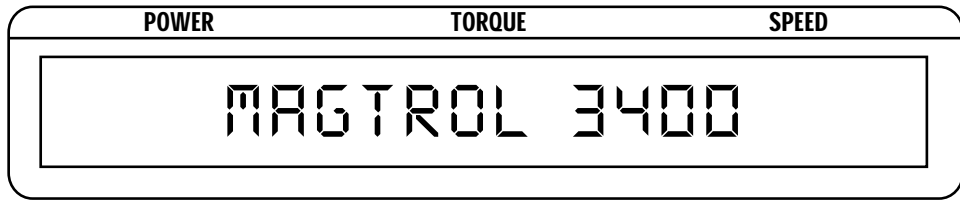

Figure 3-2 Title Display

Then an additional display will appear indicating the version of your Magtrol 3400 Torque Display.

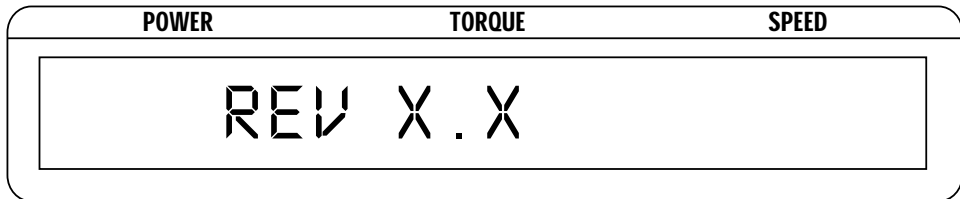

Figure 3-3 Revision Display

### 3.1.3 MAIN MENU

When the 3400 is completely powered up and ready for use, the Main Menu will appear on the display.

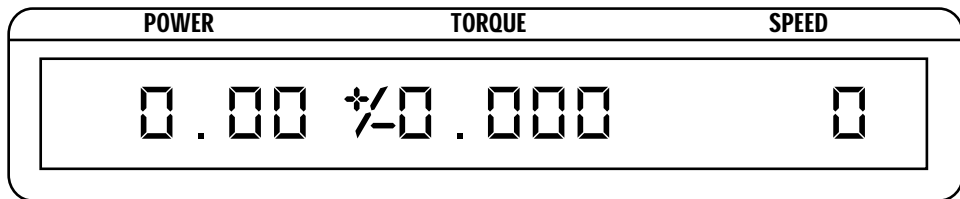

Figure 3-4 Main Menu

SETUP

---

# 4. Manually Controlled Operation

---

## 4.1 SETTING DESIRED OPERATING PARAMETERS

### 4.1.1 MODEL SETUP

Selects the desired torque transducer model. Options include TM\*04, TM\*05, TM\*06, TM\*07, TM\*08, TM\*09, TM\*10, TM\*11, TM\*12, TM\*13, TM\*14, TM\*15, TM\*16, TM\*17 and SPEC (Special), where \* represents 2 or 3 and TM = TM, TMB or TMHS.

Example: For a Model TM 204 or TM 304 Torque Transducer, select TM\*04

1. Press and release SYSTEM button. The System Display will flash momentarily.

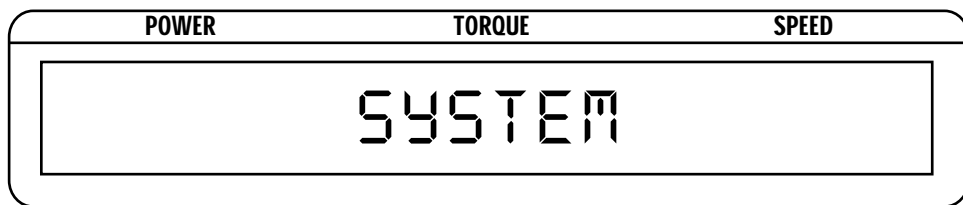

Figure 4-1 System Display

Then the Model Setup Menu will appear.

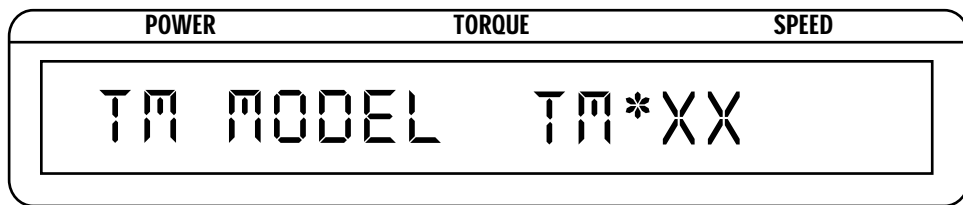

Figure 4-2 Model Setup Menu

2. Press and release SELECT button until desired torque transducer model appears in display.
3. Press and release SYSTEM button 5 times. The Saving System Display will flash momentarily.

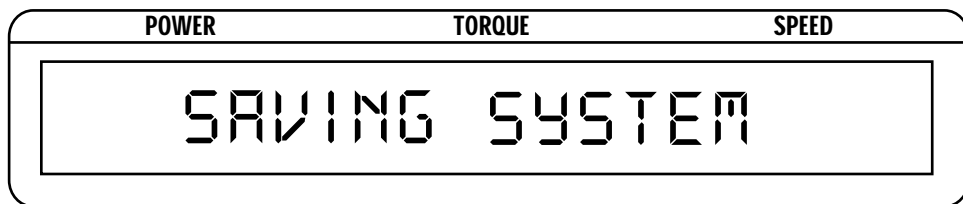

Figure 4-3 Saving System Display

Then the display will return to the Main Menu.

### 4.1.2 ENCODER SELECTION

Selects the desired torque transducer encoder. Some TM Torque Transducers have 30-bit encoders and some have 60-bit encoders. Refer to your particular TM Torque Transducer Data Sheet for the correct setting.

1. Press and release SYSTEM button 2 times.
2. Press SELECT button until desired encoder setting appears in display.
3. Press and release SYSTEM button 4 times.

### 4.1.3 TORQUE UNITS SETUP

Selects the desired unit of measure that corresponds with the values displayed. Options include: oz·in, oz·ft, lb·in, lb·ft, g·cm, kg·cm, mN·m, cN·m, N·m and kN·m .

1. Press and release SYSTEM button 3 times. The Torque Units Setup Menu will appear.

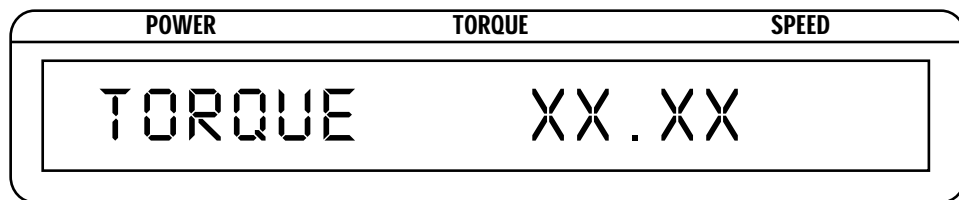

Figure 4-4 Torque Units Setup Menu

2. Press and release SELECT button until the desired unit of measure is displayed.
3. Press and release SYSTEM button 3 times. The Saving System Display will flash momentarily and the unit will automatically return to the Main Menu.

### 4.1.4 POWER UNITS SETUP

Selects the desired unit of power that corresponds with the values displayed. Options include watts, kW and hp.

1. Press and release SYSTEM button 4 times. The Power Units Setup Menu will appear.

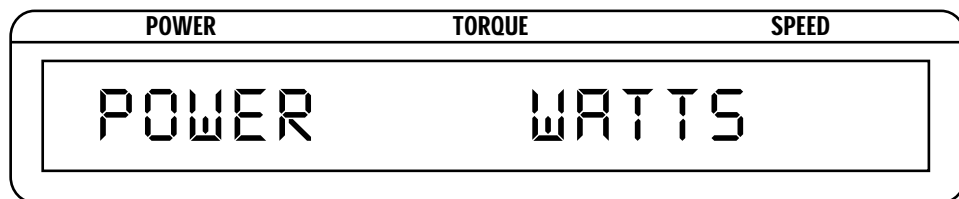

Figure 4-5 Power Units Setup Menu

2. Press and release SELECT button until the desired unit of power is displayed.
3. Press and release SYSTEM button 2 times. The Saving System Display will flash momentarily and the unit will automatically return to the Main Menu.

### 4.1.5 CONTRAST SETUP

The 3400 is shipped with the Contrast programmed to the lowest setting in order to prolong display life. If it is necessary to increase the Contrast for improved readability, execute the following steps:

1. Press and release SYSTEM button 5 times. The display appears as follows:

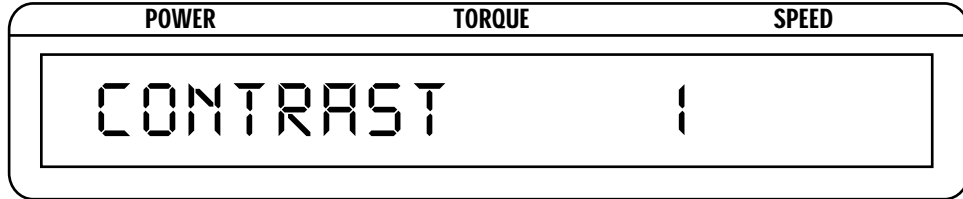

Figure 4-6 Contrast Setup Menu

2. Press and release SELECT button until desired brightness is reached (select from a range of 1 to 3).
3. Press and release SYSTEM button. The Saving System Display will flash momentarily and the unit will automatically return to the Main Menu.

### 4.1.6 SYSTEM SETUP CHECK

1. To check and make sure that all parameters have been set properly, press and hold SELECT button.

Example: When testing a TM 214, with watt power units and oz.ft torque units and 30-bit encoder, the System Check Display will appear as follows:



Note: If any setting other than a 30 or 60-bit encoder has been selected, it will be indicated in the display as \*\*.

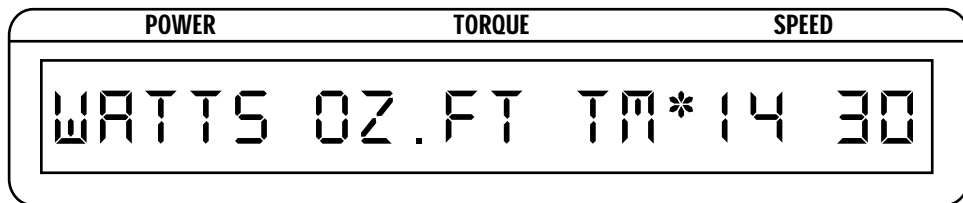

Figure 4-7 System Check Display Example

2. When the SELECT button has been released, the unit will automatically return to the Main Menu.

OPERATION

### 4.1.7 TARE FUNCTION

The calibrated offset of the 3400 may be changed using the tare function. To set:

1. Press TARE button.
2. Display will flash "TARE" and the unit will take the current value of the torque input and make it the new zero.



Note: In order to reset the tare value, the power to the unit must be turned OFF.

### 4.1.8 BITE FUNCTION

Built-In Test Equipment (BITE) has been programmed into the 3400 in order to test the system and make sure all devices are connected and running properly. To activate:

1. Press SELECT and TARE buttons simultaneously.
2. The display will flash "BITE", then provide the full-scale voltage at the input of the unit.

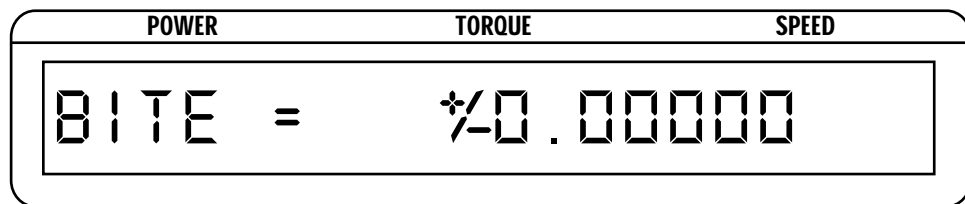

Figure 4-8 BITE Display

3. After 5 seconds, the display automatically returns to the Main Menu.

# 5. Computer Controlled Operation

The 3400 Torque Display can be used with a personal computer for standard or custom torque and encoder setups. Using the 3400 with a computer enables the unit to perform at its full capacity.

## 5.1 ABOUT THE RS-232 INTERFACE

The 3400 is equipped with an Isolated RS-232 (serial) interface that communicates with the host computer through a DB-9 interface connector. The connector pin-out consists of 2-RX, 3-TX and 5-GND.

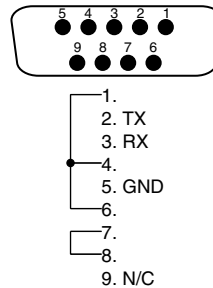

Figure 5-1 RS-232 Interface

### 5.1.1 CONNECTION

The RS-232 connection includes null modem wiring internal to the unit. To install, use a straight through pin-to-pin connector cable, which can be purchased from your local electronics store.

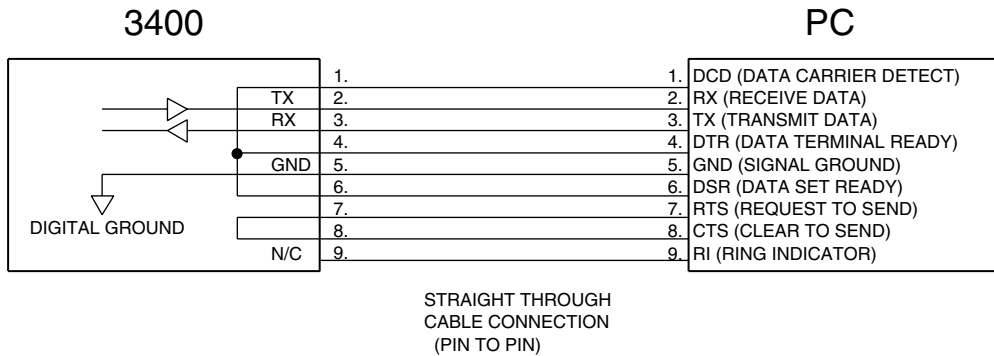

Figure 5-2 Cable Connection

### 5.1.2 COMMUNICATION PARAMETERS

- Default Baud Rate - 115200
- No parity
- 8 data bits
- 1 stop bit

## 5.2 3400 COMMAND SET

When entering a command code:

1. Type all characters in uppercase ASCII format.
2. End all commands with a CR-LF (hex 0D-0A).
3. Do not string multiple commands together in one line.

The character # represents a floating-point numerical value following the command. Leading zeroes are not required.



Note: If a command is not recognized, a COMMAND ERROR CR-LF string return will occur accompanied by a beep.

### 5.2.1 COMMUNICATION COMMANDS

Command Code	Function	Explanation
OD	Prompts to return speed-torque-direction data string.	"Output Data" prompt to return data string with this format: SxxxxxTxxxxxx<cr><lf> The speed will equal the displayed value and the torque will be in the same units as displayed on the front panel.

### 5.2.2 SETUP COMMANDS

Command Code	Function	Explanation
BITE	Activates built-in test function.	The display will flash "BITE", then provide the full-scale voltage at the input of the unit. After 5 seconds, the display automatically returns to the Main Menu.
M1	Enables rear panel controls.	Use this command to enable rear panel control of most functions.
MØ	Locks out rear panel controls.	Use this command to lock out the rear panel controls, so that the Torque Display settings can be changed only by using the computer with RS-232 interface.
TR	Resets Tare.	Resets tare to 0 (zero).
TS	Sets Tare.	Reads current torque and uses as tare value.
UE#	Sets encoder units to # when using a U14 command.	# = 0 to 6000 Programmed value # is not saved at power down.

Command Code	Function	Explanation
<b>UI#</b>	Selects model.	For hp and watts calculations to be correct, the correct torque transducer must be specified. <b>Note:</b> "TM" includes any of the TM Series Torque Transducers (TM, TMHS or TMB) and "*" represents a 2 or 3. Values for # are: 0 = TM *04, 1 Nm      8 = TM *12, 200 Nm 1 = TM *05, 2 Nm      9 = TM *13, 500 Nm 2 = TM *06, 5 Nm      10 = TM *14, 1000 Nm 3 = TM *07, 10 Nm     11 = TM *15, 2000 Nm 4 = TM *08, 20 Nm     12 = TM *16, 5000 Nm 5 = TM *09, 20 Nm     13 = TM *17, 10000 Nm 6 = TM *10, 50 Nm      14 = TM SPECIAL 7 = TM *11, 100 Nm Programmed value # is not saved at power down.
<b>UR#</b>	Sets display torque units to #.	Values for # are: 0 = oz·in      5 = kg·cm 1 = oz·ft      6 = mN·m 2 = lb·in      7 = cN·m 3 = lb·ft      8 = N·m 4 = g·cm      9 = kN·m Torque unit conversion defaults to 0 (oz·in) if out of range. Programmed value # is not saved at power down.
<b>UT#</b>	Sets torque units to # when using a UI14 command.	# = 0 to 100,000 Programmed value # is not saved at power down.
<b>SAVE</b>	Saves setup.	Saves values programmed via serial port.

5.2.3

**CALIBRATION COMMANDS**

Command Code	Function	Explanation
<b>CAL</b>	Sets unit into calibrate.	See <i>Chapter 6 - Calibration</i> .
<b>ZERO</b>	Sets the offset to the value at the input.	See <i>Chapter 6 - Calibration</i> .
<b>FS#</b>	Calibrate full scale to this value.	# = the value at input

OPERATION



---

# 6. Calibration

---

## 6.1 CLOSED-BOX CALIBRATION

The 3400 features closed-box calibration. The advantage of closed-box calibration is that the user does not have to disassemble the case or make mechanical adjustments.

The torque readout can be calibrated using external reference sources. Correction factors for offset and gain are stored in nonvolatile memory. They remain in effect until the user or the calibration house updates them.

## 6.2 CALIBRATION SCHEDULE

Calibrate the 3400:

- After any repairs are performed.
- At least once a year; more frequently to ensure required accuracy.

## 6.3 BASIC CALIBRATION PROCESS

The basic calibration process consists of two procedures which must be performed in the following order:

1. Initial Procedure
2. Torque Offset and Gain (computer)

Items needed for calibrating the 3400:

- External voltage reference of 0 to 10 volts DC
- Digital multimeter (DMM)

Both instruments should have a VDC accuracy of 0.005% or better.

### 6.3.1 INITIAL CALIBRATION PROCEDURE

1. Allow the 3400 to stabilize in an environment with:
  - An ambient temperature of 18°C to 25°C.
  - Relative humidity less than 80%.
2. Turn on the 3400.
3. Allow the 3400 to warm up for at least 30 minutes.

### 6.3.2 TORQUE OFFSET AND GAIN

1. Send the command CAL to the unit via the serial port.
2. The response will be ZERO.
3. Apply 0.0000 volts to the input.
4. Send the command ZERO.
5. The response will be FS=X.XXXX
6. Apply 5.0000 volts to the input (this can vary a few mV but measure accurately.)
7. Send the command FS=X.XXXX (where X.XXXX is your meter reading).
8. The response will be CAL COMPLETE.

---

## 7. Troubleshooting

---

<b>Problem</b>	<b>Reason</b>	<b>Solution</b>
Returned data indicates COMMAND ERROR.	Command does not match the unit's programmed set of instructions.	Use correct command and format.
Mechanical power reads much higher or lower than expected.	Torque units or scale factor is incorrect.	Set torque input units and scale factor to match the specifications of torque transducer.
No RS-232 communication.	Setup error and/or hardware fault.	Check: <ul style="list-style-type: none"><li>• Baud rate of Torque Transducer Display</li><li>• Pinout of serial cable</li><li>• Cable attachment to Torque Display and serial interface port of computer</li></ul>

If you require additional assistance, please contact Magtrol Customer Service at 1-716-668-5555.

# Appendix A: Schematics

## A.1

## 78P205 BOARD

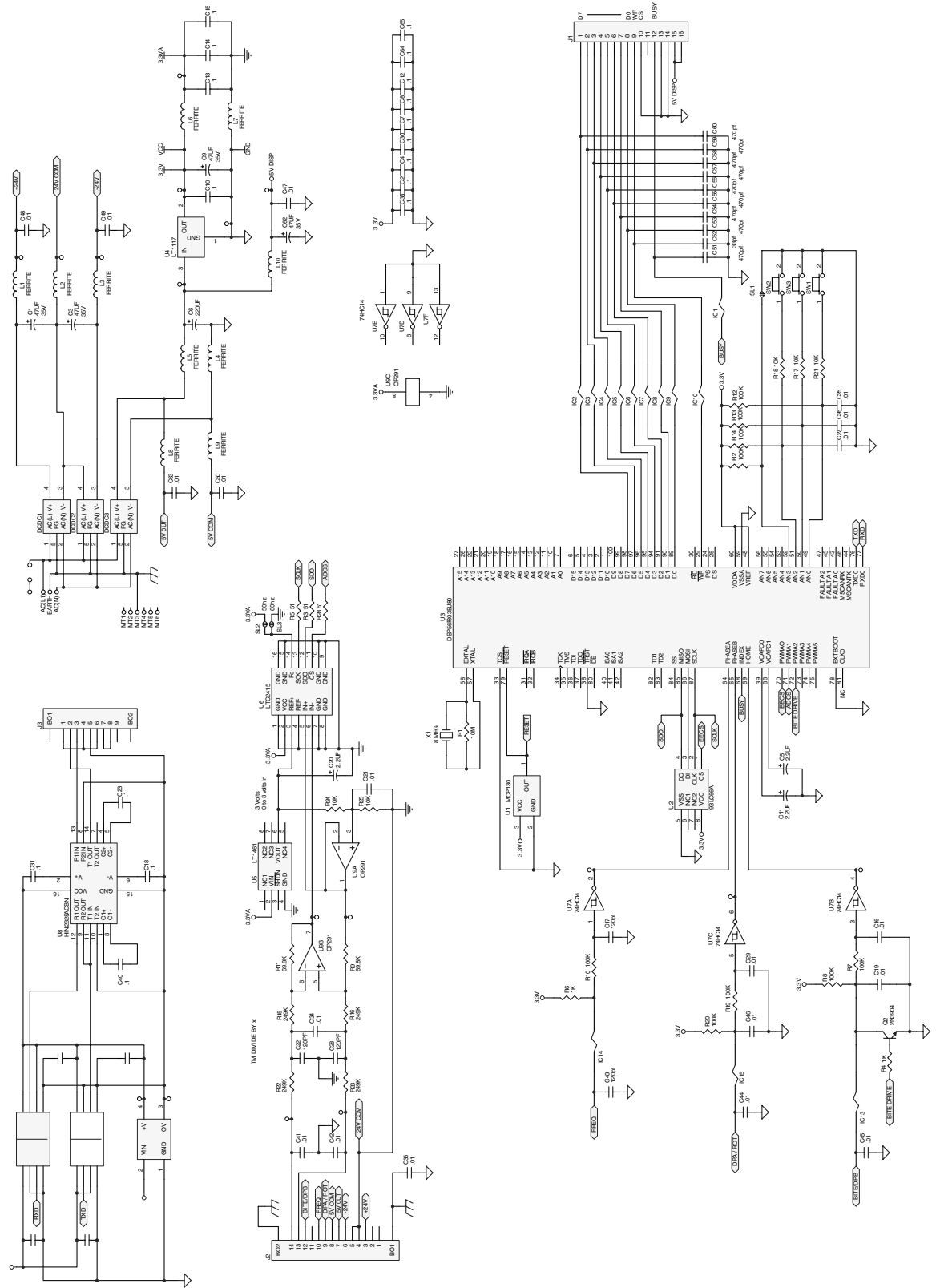

---

# Glossary

---

Following is a list of abbreviations and terms used in this manual.

<b>CR</b> .....	carriage return
<b>DMM</b> .....	digital multimeter
<b>DSP</b> .....	Digital Signal Processing
<b>hp</b> .....	horsepower; measure of mechanical power
<b>Hz</b> .....	Hertz; frequency
<b>I/O</b> .....	input/output
<b>LF</b> .....	line feed
<b>local</b> .....	manual control (use front panel controls)
<b>PC</b> .....	personal computer
<b>remote</b> .....	computer control (uses programmed controls from personal computer)
<b>rpm</b> .....	revolutions per minute
<b>RS-232</b> .....	Recommended Standard-232C, a standard interface approved by the Electronic Industries Association (EIA) for connecting serial devices.
<b>SI</b> .....	Systeme Internationale units of measure
<b>V</b> .....	volts; typically AC
<b>VDC</b> .....	volts DC

---

# Index

---

78P205 Board 18

## B

BITE 12. *See* Built-In Test Equipment

Built-In Test Equipment 12

Buttons 6

## C

Calibration 16

    Procedure 16

    Schedule 16

Calibration Commands 15

Closed-Box Calibration 16

Command Set 14–15

Commands

    Calibration 15

    Communication 14

    Setup 14

Communication Commands 14

Communication Parameters 13

Connection 7

    RS-232 13

Contrast

    Setup 11

    Setup Menu 11

Controls 6

## D

Data Sheet 2

## F

Features 1

Front Panel 4

Functions. *See also* Controls and Buttons

## G

Gain

    Torque 16

## I

Inputs 5. *See also* Outputs

## L

Line Voltage 7

## M

Main Menu 8

Menus

    Contrast Setup 11

    Main 8

    Power Units Setup 10

    Torque Units Setup 10

Model

    Setup 9

## O

Offset

    Torque 16

Outputs 5. *See also* Inputs

## P

Parameters 9

    Communication 13

Power Cord 5

Power Units

    Setup 10

    Setup Menu 10

## R

Rear Panel 5

RS-232C 5

    Connection 13

    Interface 13

## S

Schematics

    78P205 Board 18

Self-Test 7

Setup

    Contrast 11

    Model 9

    Power Units 10

    Torque Units 10

Setup Check 11

Setup Commands 14

System Setup Check 11

## T

Tare 12

Torque Offset and Gain 16

Torque Units

    Setup 10

    Setup Menu 10

Transducer Connector 5

Troubleshooting 17

## U

Unpacking 1

## V

Vacuum Fluorescent Display 4

VFD. *See* Vacuum Fluorescent Display

---

# Magtrol Limited Warranty

---

Magtrol, Inc. warrants its products to be free from defects in material and workmanship under normal use and service for a period of 24 months from the date of shipment. Software is warranted to operate in accordance with its programmed instructions on appropriate Magtrol instruments. This warranty extends only to the original purchaser and shall not apply to fuses, computer media, or any other product which, in Magtrol's sole opinion, has been subject to misuse, alteration, abuse or abnormal conditions of operation or shipping.

Magtrol's obligation under this warranty is limited to repair or replacement of a product which is returned to the factory within the warranty period and is determined, upon examination by Magtrol, to be defective. If Magtrol determines that the defect or malfunction has been caused by misuse, alteration, abuse or abnormal conditions of operation or shipping, Magtrol will repair the product and bill the purchaser for the reasonable cost of repair. If the product is not covered by this warranty, Magtrol will, if requested by purchaser, submit an estimate of the repair costs before work is started.

To obtain repair service under this warranty, purchaser must forward the product (transportation prepaid) and a description of the malfunction to the factory. The instrument shall be repaired at the factory and returned to purchaser, transportation prepaid. **MAGTROL ASSUMES NO RISK FOR IN-TRANSIT DAMAGE.**

THE FOREGOING WARRANTY IS PURCHASER'S SOLE AND EXCLUSIVE REMEDY AND IS IN LIEU OF ALL OTHER WARRANTIES, EXPRESSED OR IMPLIED, INCLUDING BUT NOT LIMITED TO ANY IMPLIED WARRANTY OF MERCHANTABILITY, OR FITNESS FOR ANY PARTICULAR PURPOSE OR USE. MAGTROL SHALL NOT BE LIABLE FOR ANY SPECIAL, INDIRECT, INCIDENTAL, OR CONSEQUENTIAL DAMAGES OR LOSS WHETHER IN CONTRACT, TORT, OR OTHERWISE.

## CLAIMS

Immediately upon arrival, purchaser shall check the packing container against the enclosed packing list and shall, within thirty (30) days of arrival, give Magtrol notice of shortages or any nonconformity with the terms of the order. If purchaser fails to give notice, the delivery shall be deemed to conform with the terms of the order.

The purchaser assumes all risk of loss or damage to products upon delivery by Magtrol to the carrier. If a product is damaged in transit, **PURCHASER MUST FILE ALL CLAIMS FOR DAMAGE WITH THE CARRIER** to obtain compensation. Upon request by purchaser, Magtrol will submit an estimate of the cost to repair shipment damage.



*Testing, Measurement and Control of Torque-Speed-Power • Load-Force-Weight • Tension • Displacement*

[www.magtrol.com](http://www.magtrol.com)

**MAGTROL INC**

70 Gardenville Parkway  
Buffalo, New York 14224 USA  
Phone: +1 716 668 5555  
Fax: +1 716 668 8705  
E-mail: [magtrol@magtrol.com](mailto:magtrol@magtrol.com)

**MAGTROL SA**

Route de Moncor 4B  
1701 Fribourg, Switzerland  
Phone: +41 (0)26 407 3000  
Fax: +41 (0)26 407 3001  
E-mail: [magtrol@magtrol.ch](mailto:magtrol@magtrol.ch)

**Subsidiaries in:**

- Germany
- France
- Great Britain

Worldwide Network  
of Sales Agents

Magtrol SA ISO 9001:2000 certified

