

AN SERIES

CODE: 30727296 EDITION: 08.09.2015



**INSTRUCTION MANUAL
MULTIFUNCTION INDICATOR FOR PROCESS CONTROL
TEMPERATURE AND LOAD CELL**

AN 1500 M

CE

INDEX

| | |
|--|----|
| 1. OVERVIEW | 4 |
| 1.1. Introduction to model AN 1500 M | 4 |
| 2. GETTING STARTED | 5 |
| 2.1. Power supply and connectors | 9 |
| 2.2. Instrument front panel | 10 |
| 2.3. Programming instructions..... | 10 |
| 3. INPUT PROGRAMMING | 11 |
| 3.1. Process input Programming | 13 |
| 3.1.1. Transducer connection (V, mA)..... | 13 |
| 3.1.2. Wiring diagram for mA input..... | 14 |
| 3.1.3. Wiring diagram for V input | 15 |
| 3.2. Load cell input Programming | 16 |
| 3.2.1. Load cell connection (mV/ V)..... | 17 |
| 3.3. Thermometer Pt 100 input programming..... | 18 |
| 3.3.1. Pt100 input connection..... | 19 |
| 3.4. Thermocouple input programming | 20 |
| 3.4.1. Thermocouple input connection (J, K, T, N)..... | 21 |
| 4. DISPLAY PROGRAMMING | 22 |
| 4.1. Scale..... | 23 |
| 4.1.1. Scale programming | 24 |
| 5. FUNCTIONS BY KEYBOARD AND BY CONNECTOR | 28 |
| 5.1. Functions by keyboard | 28 |
| 5.2. Functions by connector | 30 |
| 5.2.1. Logical functions diagram..... | 31 |
| 5.2.2. Table of programmable functions..... | 31 |
| 5.2.3. Functions programming..... | 33 |

| | |
|--|----|
| 6. PROGRAMMING LOCK-OUT BY SOFTWARE | 34 |
| 6.1. Security menu diagram | 35 |
| 7. OUTPUT OPTIONS | 38 |
| 7.1. SETPOINTS OUTPUT | 40 |
| 7.1.1. Introduction | 40 |
| 7.1.2. Functioning description | 41 |
| 7.1.3. Set up | 42 |
| 7.1.4. Wiring | 42 |
| 7.1.5. Technical Specifications..... | 43 |
| 7.1.6. Setpoints menu diagram | 44 |
| 7.1.7. Direct access to programming of setpoints value | 45 |
| 7.2. RS2/ RS4 OUTPUT | 46 |
| 7.2.1. Introduction | 46 |
| 7.2.2. RS output menu diagram..... | 47 |
| 7.3. ANALOG OUTPUT..... | 53 |
| 7.3.1. Introduction | 53 |
| 7.3.2. Installation of option NMA or NMV | 53 |
| 7.3.3. Wiring | 54 |
| 7.3.4. Technical Specifications..... | 55 |
| 7.3.5. Analog output menu Diagram | 55 |
| WARRANTY | 56 |
| TECHNICAL SPECIFICATIONS | 57 |

| |
|------------------------------------|
| Valid for M2.00 version or higher. |
|------------------------------------|

1. OVERVIEW

1.1 Introduction to model AN 1500 M

The AN 1500 M model from the AN SERIES is a digital multifunction instrument which allows the user to program the input as a:

- PROCESS INPUT (V, mA)
- LOAD CELL INPUT (mV)
- Pt100 INPUT
- THERMOCOUPLE INPUT (J, K, T, N)

The basic instrument is a soldered assembly composed of a main board, a **tricolor programmable display** and a power circuit.

Standard features of the basic instrument include the reading of the input variable as well as remote hold, reading and memorisation of max and min values (peak/ valley), tare and reset function, and a full complement of programmable logic functions.

In addition, a variety of plug-in **output** cards can be installed at any time to meet further system requirements:

COMMUNICATION

RS2 Serial RS232C

RS4 Serial RS485

ETH Ethernet (Allows access to the embedded web server for process variables remote monitoring).

CONTROL

NMA Analogue 4-20mA

NMV Analogue 0-10V

2RE 2 Relays SPDT 8A

4RE 4 Relays SPST 5A

4OP 4 NPN output

4OPP 4 PNP output

All the output options are optoisolated from input signal and power supply.

2. GETTING STARTED

Packing contents

- ❑ Instruction manual in English including declaration of conformity
- ❑ Digital panel meter AN 1500 M.
- ❑ Accessories for panel mounting (sealing gasket and fixing clips).
- ❑ Accessories for wiring connections (plug-in terminal block connectors with a fingertip key).
- ❑ Wiring label stuck to the AN 1500 M case.
- ❑ 4 set of labels with engineering units.
- ✓ ***Check the packing contents.***

Programming instructions

- ❑ The Instrument has a software that via keyboard allows accessing to several independents programming menus for configuration of the input, the display and the logic functions. If additional options are installed (serial outputs, analogue output and relays output, once recognised by the instrument, they activate their own programming software.
- ✓ ***Read carefully this section.***

Programming lock-out (Page 34).

Software allows total programming lockout but also selective lockout of the programming parameters.

- ❑ The instrument is delivered from factory with unlocked programming, e.g., with all the programming levels accessible to the operator

Write down the security code and keep it in a secure place.

The figure below shows the locations of the different output options available.

The **2RE, 4RE, 4OP y 4OPP** options are alternative and only one of them can be installed in the M1 connector.

The **RS2, RS4** and **ETH** options are also alternative and only one of them can be installed in the M2 connector.

The **NMA** or **NMV** are also alternative and only one of them can be installed in the M3 connector.

Up to three output options can be installed and operate simultaneously:

- 4-20mA or 0-10V (only one)
- RS232C, RS485 or ETH (only one)
- 2 RELAYS, 4 RELAYS o 4 OPTO (only one).

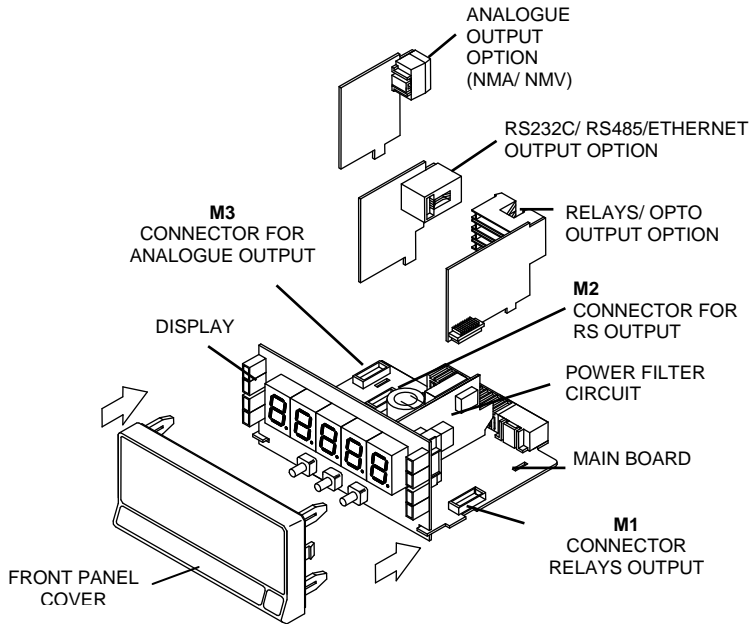

Dimensions and mounting

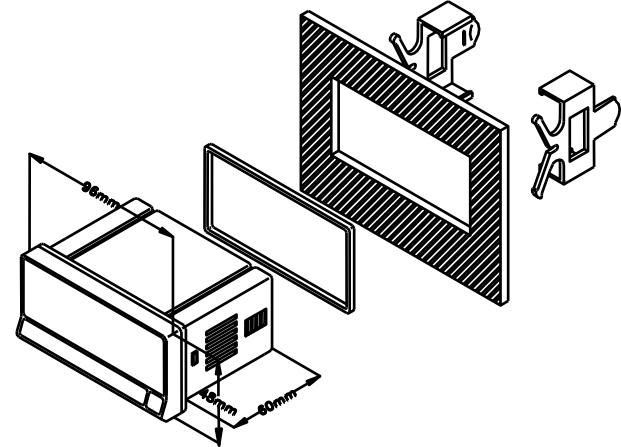

Front: 96 x 48 mm Depth: 60 mm
Panel cut-out: 92 x 45 mm

CLEANING: frontal cover should be cleaned only with a soft cloth soaked in neutral soap product.
DO NOT USE SOLVENTS



How to get into programming mode?

First, plug the instrument to the corresponding supply, automatically a display test will be done and after that the software version will be shown then the instrument will go to work mode. Second, press the  key to enter into the programming mode, the indication "-Pro-" will appear on the display then.

How to store programmed parameters?

If we want to save the changes that we have done in the programming, we must complete the programming of all the parameters contained in the routine we are in. In the last step of the routine, as a result of pressing on the  key, "StorE" will be displayed during a few seconds, meanwhile all the data are stored in memory. Then the instrument will go back to working mode.

How is programming routine organised?

Programming software is composed by a number of menus and submenus hierarchically organized. On figure below, beginning with indication "-Pro-", press repeatedly  to get access to programming menus. Modules 3, 4 and 5 will only be shown if the option for setpoints, analogue output, RS option or Ethernet option has been plugged in. Selecting one menu, the access to the different programming submenus is done by pressing .

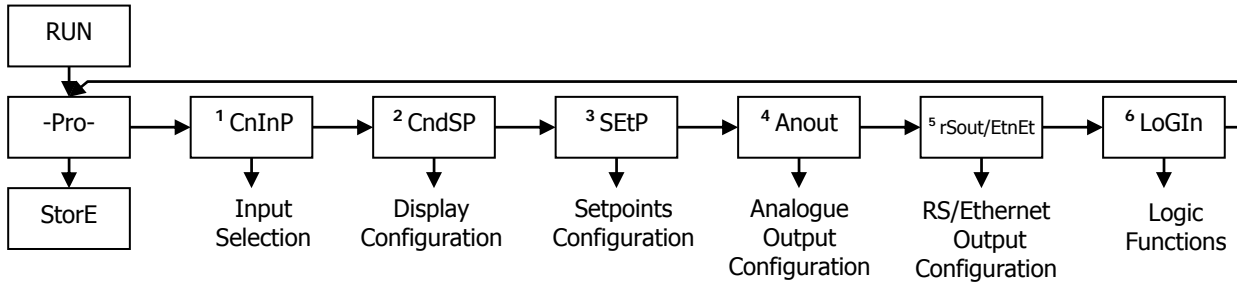



Module selection level

Accessing to programmed parameters

Thanks to the tree structure, the programming routines allow to access to change one parameter without passing through the whole list of parameters.

To advance through programming

The progress through the programming routines is done by pressing  key.

In general, the steps to be done will be push  key a certain number of times to select an option and push  key to validate the change and going forward to the next step of the program.

The numerical values are programmed digit by digit as explained in the next paragraph.

Programming numerical values

When the parameter is a numerical value, the display will show the first of the digit to be programmed blinking.

The method of introducing a value is as follow:

Digit selecting: Press repeatedly the  key to shift from left to right over all the display digits.

Changing the digit value: Press repeatedly the  key to increase the value of blinking digit until it has the desired value.

The minus sign is programmed depending on the variable type. A variable that represents the value of an input will be able to take a value in the range -19999 to 99999, without taking into account the decimal point. When change the first digit, this shows values from (0) to (9), and then (-1), (-), and comes back to show values from 0 to 9.

A variable that represents a display value will be able to take a value in the range -19999 to 39999, without taking into account the decimal point. In these case the first digit shows 0, 1, -1, 2, 3 or -.

Selecting an option from the list

When the parameter is an option to be chosen among different possibilities, the  key allows you to browse through the list of options until you find the desired parameter

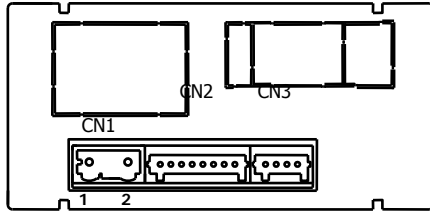
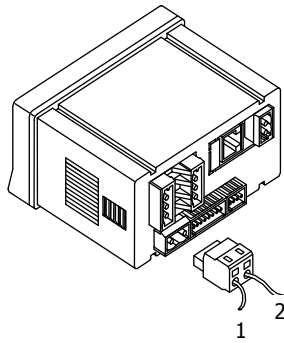

WIRING and POWER SUPPLY RANGE

AN 1500 M

85 V – 265 V AC 50/ 60 Hz to 100 – 300 V DC

AN 1500 M6

22 – 53 V AC 50/ 60 Hz to 10,5 - 70 V DC

Borne 1: Phase

Borne 2: Neutral

NOTE: When DC power supply (direct) polarity in connector CN1 is indistinct.

WARNING: If not installed and used in accordance with these instructions, protection against hazards may be impaired.

In order to guarantee the electromagnetic compatibility, the following guidelines should be kept in mind:

- Power supply wires may be routed separated from signal wires.
- Never run power and signal wires in the same conduit.
- Use shielded cable for signal wiring and connect the shield to the ground of the indicator.
- The cables section should be $\geq 0.25 \text{ mm}^2$

INSTALLATION

To meet the requirements of the directive EN61010-1, where the unit is permanently connected to the mains supply, it is obligatory to install a circuit breaking device easy reachable to the operator and clearly marked as the disconnect device.

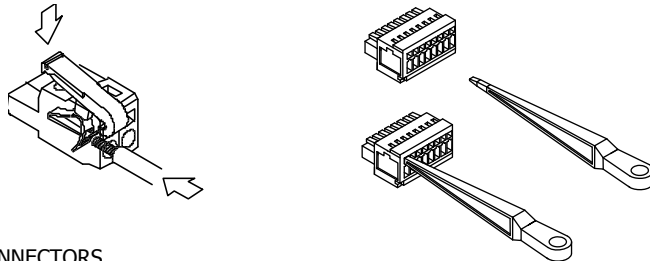

CONNECTORS

CN1 To perform wiring connections, strip the wire leaving from 7 and 10 mm exposed to air and insert it in the proper terminal while pushing the fingertip down to open the clip inside the connector as indicated in the figures. Each terminal accepts cables of section between 0.08 mm^2 and 2.5 mm^2 (AWG $26 \div 14$).

CN2 & CN3 To perform wiring connections, strip the wire leaving from 5 and 6 mm exposed to air and insert it in the proper terminal while pushing the fingertip down to open the clip inside the connector as indicated in the figures. Each terminal accepts cables of section between 0.08 mm^2 and 0.5 mm^2 (AWG $28 \div 20$).

2.2 –Instrument frontal view

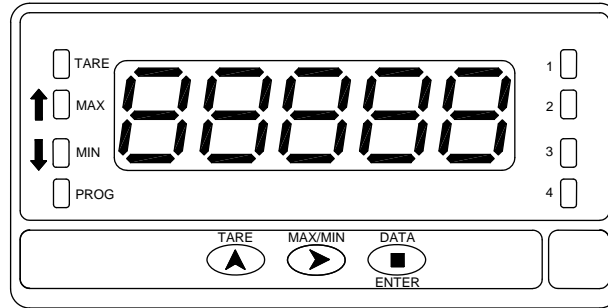

2.3 – Programming guide

The different steps to be followed for a correct programming of each type of function are detailed below. The reading and application of some paragraphs are obligatory (O), recommendable (R) or optional (op).

As Process indicator:

1. Input Configuration, Page. 13 (O).
2. Input Connection, Page. 14 - 15 (O).
3. Display Configuration, Page 22 (O).
4. Program remote inputs, Pag. 30 (R).
5. Install and configure output option(s) Page. 38 (op)
6. Programming lock-out, Page. 34 (R).

As Load cell indicator

1. Input Configuration, Page. 16 (O).
2. Input Connection, Page. 17 (O).
3. Display Configuration, Page. 22 (O).
4. Program remote inputs, Pag. 30 (R).
5. Install and configure output option(s) Page. 38 (op).
6. Programming lock-out, Page. 34 (R).

As thermometer Pt100:

1. Input Configuration, Page. 18 (O).
2. Input Connection, Page. 19 (O).
3. Program remote inputs, Pag. 30 (R).
4. Install and configure output option(s) Page. 38 (op).
5. Programming lock-out, Page. 34 (R).

As thermometer thermocouple:

1. Input Configuration, Page. 20 (O).
2. Input Connection, Page. 21 (O).
3. Program remote inputs Pag. 30 (R).
4. Install and configure output option(s) Page 38 (op).
5. Programming lock-out, Page. 34 (R).

3. INPUT CONFIGURATION

The figure below shows the input configuration menu. Divided into four submenus, each one of them separated by the dotted line in the manual, each menu corresponds to the programming of the different types of input: process, load cell, thermometer Pt100 and thermometer thermocouple. The data requested in each case are indicated below.

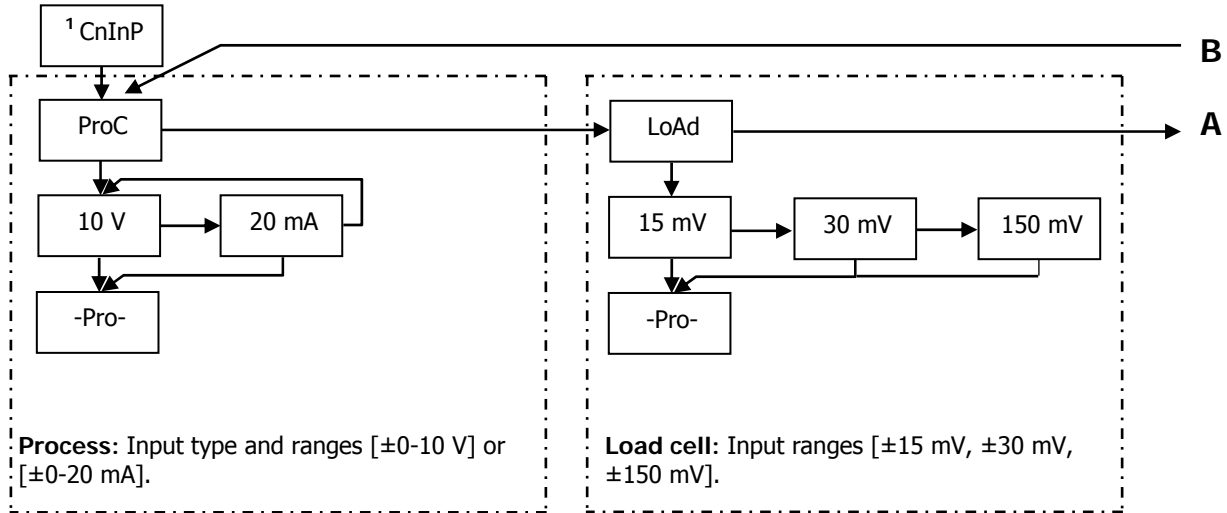

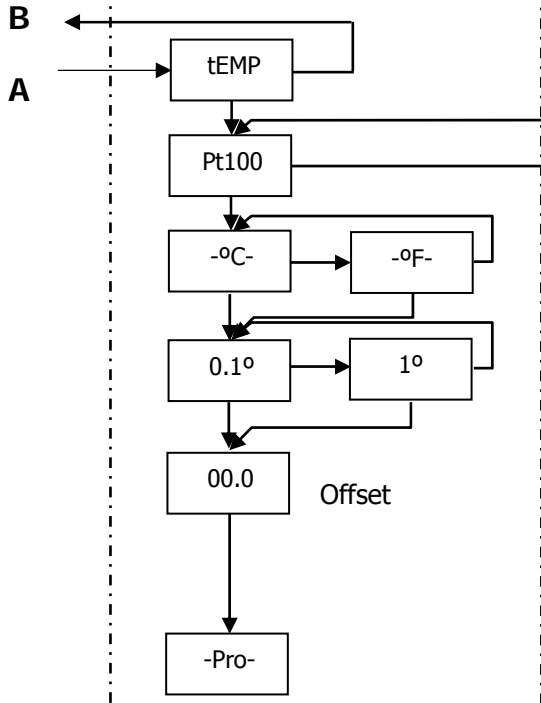

Pt100 thermometer:
 Units [°C, °F]
 Resolution [0.1°, 1°]
 Offset [-19.9° to + 99.9° degrees]

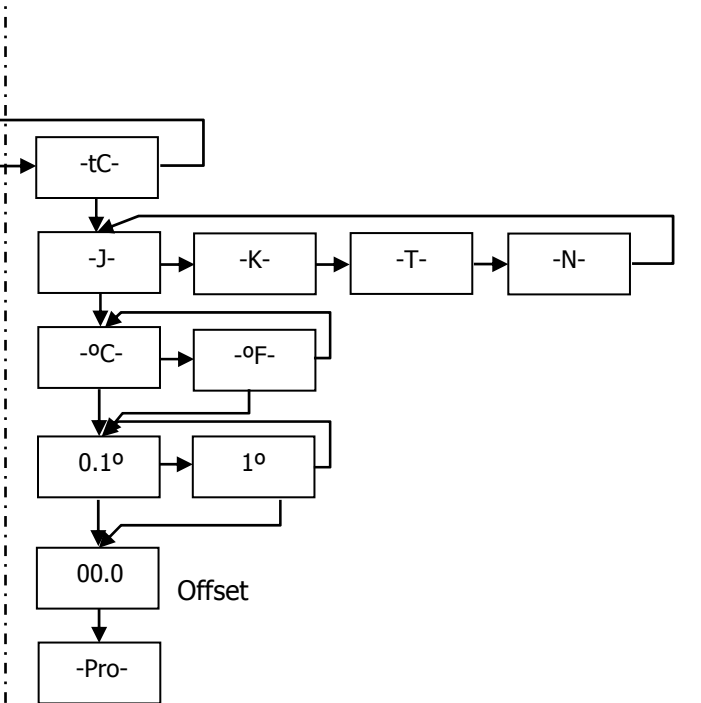

Thermocouple Thermometer:
 Type of input thermocouple [J, K, T, N]
 Units [°C, °F]
 Resolution [0.1°, 1°]
 Offset [-19.9° to + 99.9° degrees]

3.1 – Program process input

As process indicator it is designed to measure all kinds of process variable with direct indications in engineering units.

The parameter to configure as process indicator is the input type, in volts in a -10 V to 10 V range and in milliamperes in a -20 mA to 20 mA range.

3.1.1 – transducer connection (V, mA)

Refer to wiring guidelines in Page. 9.

Instrument's rear view

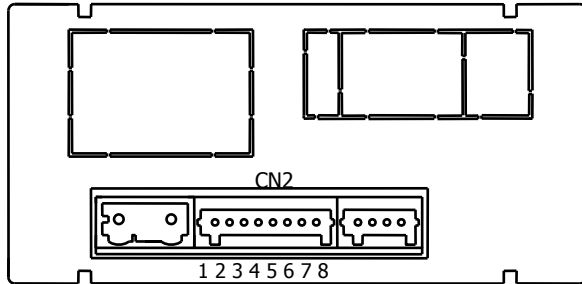

CONNECTOR SIGNAL INPUT

CN2

| | | |
|---------|------|------------------------------------|
| PIN 1 = | -EXC | [excitation output (-)] |
| PIN 2 = | +EXC | [excitation output +24V (+)] |
| PIN 3 = | +EXC | [excitation output +5V or 10V (+)] |
| PIN 4 = | N/C | [no connection] |
| PIN 5 = | +IN | [input mA (+)] |
| PIN 6 = | +IN | [input V (+)] |
| PIN 7 = | N/C | [no connection] |
| PIN 8 = | -IN | [input V (-), mA(-)] |

3.1.2 WIRING DIAGRAM FOR INPUT mA ($\pm 0-20$ mA/ 4-20 mA)

CONNECTION WITH EXT. EXCITATION

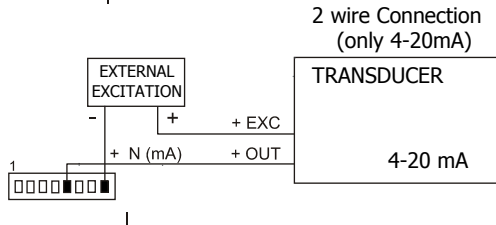
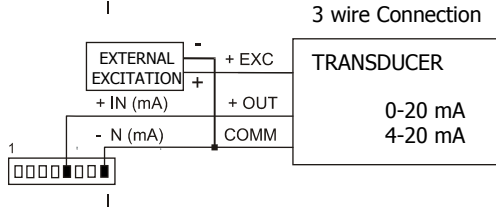
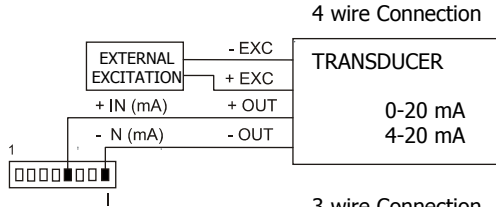

EXCITATION SUPPLIED BY AN 1500 M

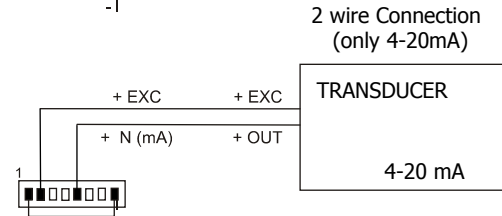
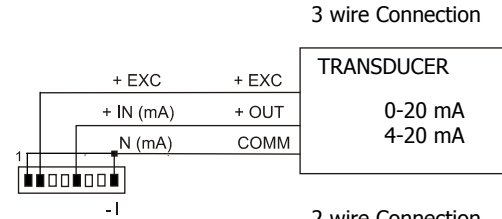
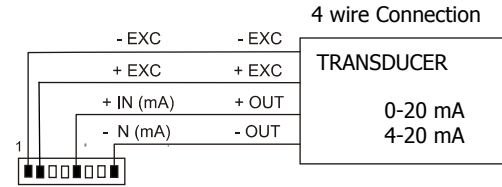

If the excitation supplied by AN 1500 M to the transducer has to be 10 or 5 V connect the + EXC wire to PIN3 instead of PIN2

3.1.3 WIRING DIAGRAM FOR INPUT V ($\pm 0-10$ V)

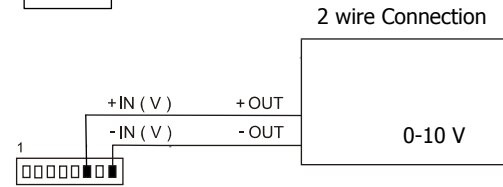
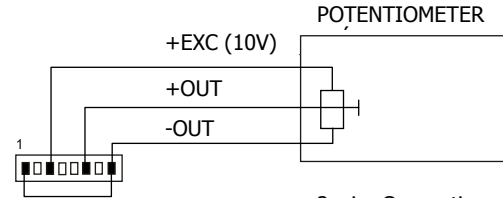
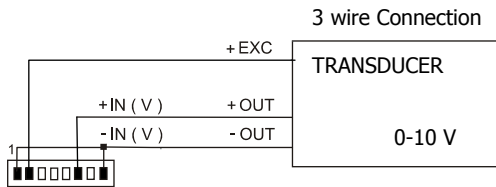
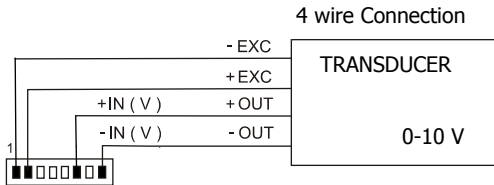
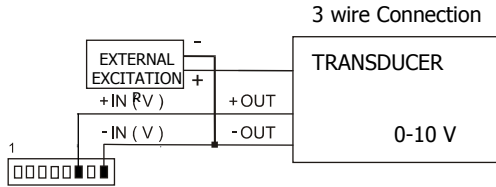
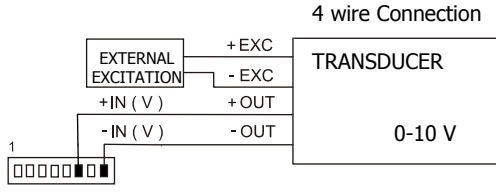

If the excitation supplied by AN 1500 M to the transducer has to be 10 or 5 V connect the + EXC wire to PIN3 instead of PIN2

3.2 – Programming of Load cell input

Refer to cell manufacturer's documentation, particularly with respect to the cell sensitivity and supply voltage specifications.

As load cell indicator the meter's function is to measure forces (weight, pressure, torque...) applied to a dispositive connected to several bridge type transducers such as load cell, which supply signal levels up to ± 150 mV.

The two excitation voltages supplied by this instrument are 10 V and 5 V. The selection is realised through the configuration of the internal bridge excitation (see Fig.). This way up to 2 cells can be connected in parallel with 10 V excitation and up to 4 cells with 5 V excitation, without need for an external source (see connection Page. 17).

Example:

2 cells with 2 mV/V sensibility are supplied with an excitation voltage of 10 V; the voltage generated by each cell at full load is 20 mV, being 20 mV the maximum as the cells are connected in parallel. In the same case but with a 5 V excitation, the maximum voltage generated will be 10 mV.

Software configuration requires selection of the input range which may be selected high enough for the maximum input signal to avoid overloads. There are three ranges: ± 15 mV, ± 30 mV and ± 150 mV

Example:

If a weighing process gives 12 mV to the meter input with maximum load, the best input range to select will be "15 mV".

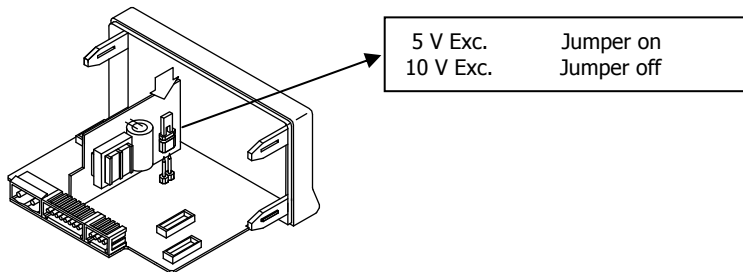

Selection of voltage excitation 10 V or 5 V

3.2.1 – Load cell connection (mV/ V)

Refer to wiring guidelines in Page. 9.

Instrument's rear view

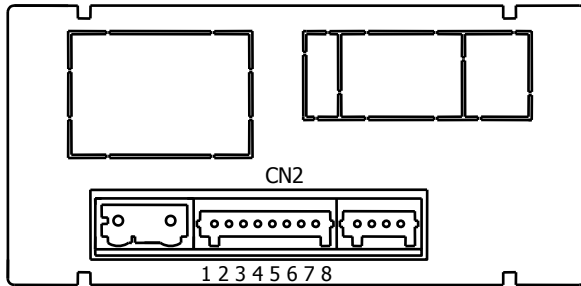

CONNECTOR SIGNAL INPUT

CN2

- PIN 1 = -EXC [excitation output (-)]
- PIN 2 = +EXC [no connection]
- PIN 3 = +EXC [excitation output +5V or 10 V (+)]
- PIN 4 = N/C [no connection]
- PIN 5 = N/C [no connection]
- PIN 6 = N/C [no connection]
- PIN 7 = +mV [input mV (+)]
- PIN 8 = -mV [input mV (-)]

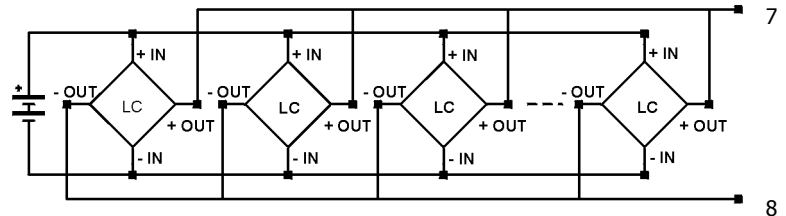
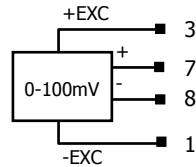
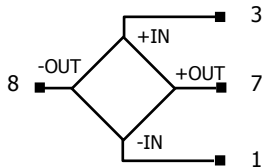

3.3 - Programming of Pt100 thermometer input

When configuring the meter as thermometer for 3 wires Pt100 sensors, the temperature ranges and resolution available are:

| Input | Range (res. 0.1 °) | Range (res. 1°) |
|-------|----------------------|------------------|
| Pt100 | -200.0 to +800.0 °C | -200 to +800 °C |
| | -328.0 to +1472.0 °F | -328 to +1472 °F |

The Pt100 software menu allows selection of temperature units (Celsius or Fahrenheit), resolution (degree or tenth of degrees) and a display offset. Offset value is programmed if we know that a difference may exist between the temperature under measurement and the temperature read by the sensor. This difference can be corrected by programming an offset from -19.9 to +99.9. **LED TARE will light up each time that an offset value is programmed.**

Example:

In a process of temperature control the Pt100 sensor is located in a part of the process where temperature is 10 degrees below than in the point in where the control has to be done. By programming an offset of 10 points, with 1 degree resolution, the deviation will be corrected.

Configurable parameters for this input are:

- a) Reading units in degree Celsius "°C" or Fahrenheit "°F".
- b) Resolution in tenth of degrees "0,1°" or in whole degrees "1°".
- c) Offset. The instrument comes from factory with offset=0

After entering these parameters, the display range and linearization are adjusted automatically.

3.3.1 - Pt100 input connection

Instrument's rear view

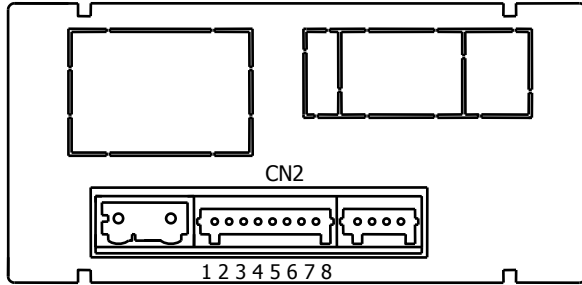

Pt100 wiring diagram

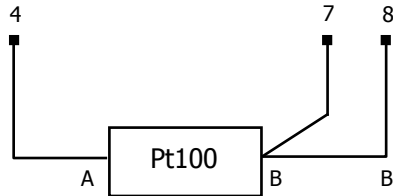

CONNECTOR SIGNAL INPUT

CN2

- PIN 1 = No connection
- PIN 2 = No connection
- PIN 3 = No connection
- PIN 4 = Pt100 A
- PIN 5 = No connection
- PIN 6 = No connection
- PIN 7 = Pt100 B
- PIN 8 = Pt100 B

3.4 – Programming of Thermocouple input

When configuring the meter for thermocouple input, the temperature ranges and resolution available are:

| Input | Range (res. 0,1 °) | Range (res. 1°) |
|----------------|----------------------|------------------|
| Thermocouple J | -150,0 to +1100,0 °C | -150 to +1100 °C |
| | -238,0 to +2012,0 °F | -238 to +2012 °F |
| Thermocouple K | -150,0 to +1200,0 °C | -150 to +1200 °C |
| | -238,0 to +2192,0 °F | -238 to +2192 °F |
| Thermocouple T | -200,0 to +400,0 °C | -200 to +400 °C |
| | -328,0 to +752,0 °F | -328 to +752 °F |
| Thermocouple N | -150,0 to +1300,0 °C | -150 to +1300 °C |
| | -238,0 to +2372,0 °F | -238 to +2372 °F |

The thermocouple software menu allows selection among several types of thermocouples, temperature units (Celsius or Fahrenheit), resolution (degree or tenth of degrees) and a display offset. Offset value is programmed if we know that a difference may exist between the temperature under measurement and the temperature read by the sensor. This difference can be corrected by programming an offset from -19.9 to +99.9. **LED TARE will light up each time that an offset value is programmed.**

Example:

In a process of temperature control the thermocouple sensor is located in a part of the process where temperature is 5 degrees below than in the point in where the control has to be done. By programming an offset of 5 points, with 1 degree resolution, the deviation will be corrected.

Configurable parameters for this input are:

- k) Thermocouple type [J, K, T, N].
- l) Reading units in degree Celsius "°C" or Fahrenheit "°F".
- m) Resolution in tenth of degrees "0,1°" or in whole degrees "1°".
- n) Offset. The instrument comes from factory with offset=0

After introducing these parameters, the display range and linearization for the selected thermocouple input are adjusted automatically.

3.4.1 – Thermocouple (J, K, T, N) input connection

Refer to wiring guidelines in Page. 9.

Instrument's rear view

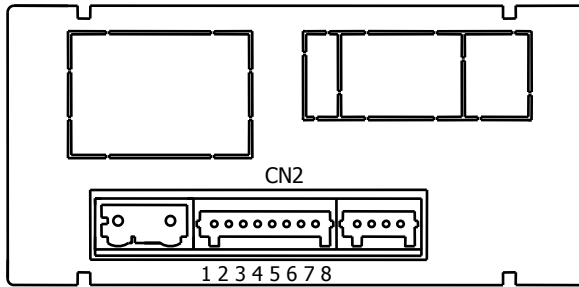

CONNECTOR SIGNAL INPUT

CN2

- PIN 1 = No connection
- PIN 2 = No connection
- PIN 3 = No connection
- PIN 4 = No connection
- PIN 6 = No connection
- PIN 7 = +TC
- PIN 8 = - TC

Thermocouples wiring diagram

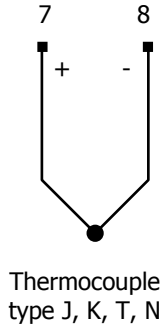

4. DISPLAY CONFIGURATION

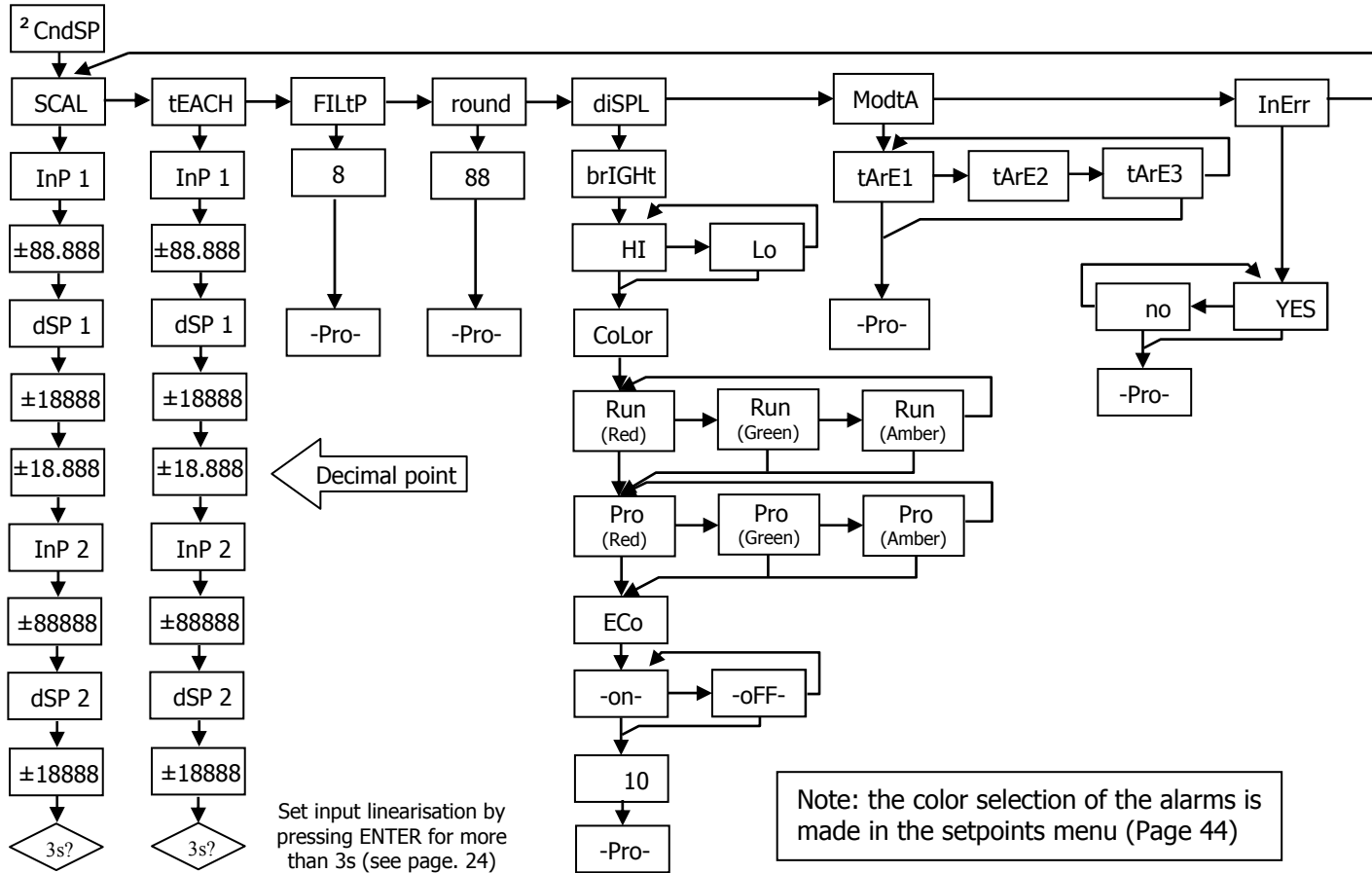

4.1. Scaling

It is only necessary to scale the meter when it has been configured for **process o load cell**. Scaling consist of assigning a display value to each input signal value.

Direct scale

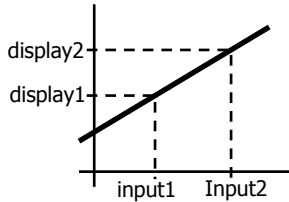

Reversed scale

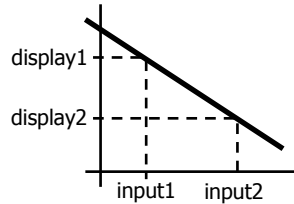

In linear processes it is achieved by programming two coordinates (input1, display1) and (input2, display2), between which is established a linear relation where to each input signal value corresponds a display value. The relationship can be direct or reversed. In order to obtain more accuracy, points 1 and 2 should be located approximately at both extremes of the process.

In nonlinear processes it is possible to program up to 11 points input-display. Each two points are connected by a straight line and the whole is a curve that represents the relationship between the input value and the display value.

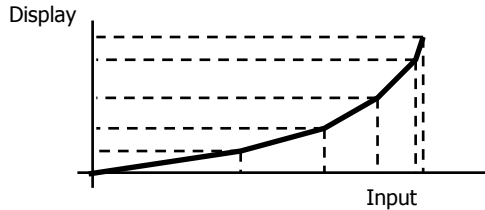

In order to obtain more accuracy in the measuring it is recommended to program the highest possible number of points and reduce the segment length.

Input values must always be programmed in an increasing or decreasing order. Avoid assigning two different display values to two equals input values.

Display values can be entered in any order and even be repeated for different inputs.

Below the first point programmed, the relationship established between the two first points of the scale is followed. Above the last point programmed, the relationship established between the two last points of the scale is followed.

4.1.1 Programming of the scale

There are two methods for programming the scale, the **SCAL** method and the **tEACH** method. In the following diagram the SCAL menu has been developed as an example, it is exactly the same menu than the tEACH menu.

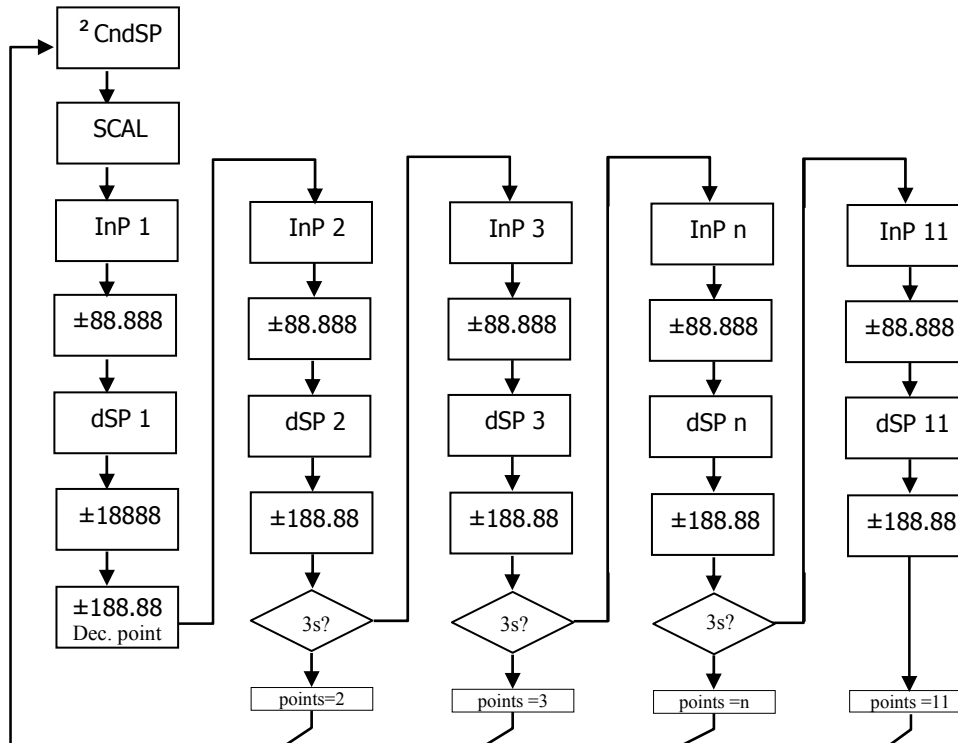

SCAL method





The input and display values are programmed manually. This method can be used when the value of the signal supplied by the transducer at each points of the process is known.

tEACH method

The input values are introduced directly from the signal present in the input connector when each point is programmed. The display values are programmed manually.

This method can be used when it is possible to bring the process to the conditions of each one of the points to be programmed.

Programming of the linearization points

You can accede to the first two points input-display by pressing on the  key. To accede to the programming of the rest of the points, press on  key during approximately 3s from the display value of point 2. From here the progression is achieved by pressing on  key. When enough points has been programmed to define the process, press on  during 3s from the programming of the last DSP n value, to get out of the scale programming routine. The rest of the points, up to 11, that have not been programmed are omitted from the display calculation.

Input points

- 19999 to 99999

Display points

- 19999 to 39999

Display decimal point

0 0.0 0.00 0.000 0.0000

Accessible from the SCAL or tEACH menu, following the first display point. Once acceded to it , it will start to blink in its present position and through the  key will be able to shift to another position.

Moreover it will also affect, as well as the display points, the setpoints value and the value of the analog output scale, in case the corresponding option has been installed.

Filter P

0 to 9

Filter of ponderated average. The value will be modified through the  key. This parameter will set in reverse order the cut-off frequency of the low pass filter, getting the filter deactivated for 0 value. **Not available when the instrument is configured for temperature measurement.**

Round

01 05 10

Will take each one of the values by pressing successively on the  key. with 01 there will be no round, 05 will round the display value at 0 o 5, and with 10 will round at 0 o 10. Just like the previous variable **not available when the instrument is configured for temperature measurement..**

Brightness

Hi Lo

Display brightness level selection.

Hi: high brightness

Lo: low brightness

Display color selection between green, red or amber is possible for both **RUN** and **PRO** modes.

Eco

on off

Allows choosing an operative mode with an up to **45% of ENERGY SAVING***

on: After a programmable time without pressing any key, display will turn off leaving only the right decimal point flashing; all functions remain active. Display will be again active after pressing any key.

oFF: Deactivates the function.

*Measured at 230V AC power supply, display 100.00, amber colour and with no options.

Input Error

YES: If input signal is lower than the minimum, display will show "- - - - -".

No: Without indication.

(For more information see specifications on page 58)



Tare mode

By pressing  key, we can select the mode in which the instrument will treat the process to tare. Each time you accede this menu, the tare value stored in the instrument memory will reset, and as usual when the instrument is in this state, the TARE led will stay off. Once selected the operation mode, we go to the "RUN" mode, from where will be made the tare process.



tArE 1

In mode tArE1 the instrument, pressing on the  key, stores the current displayed value unless it is over scaled, the TARE Led will light up and from this moment the value displayed is the net value, i.e., the measured value minus the value stored in the tare. If having the instrument a tare, we press one more time on the same key, the value displayed at this moment will add up to the tare previously stored, the addition of both will make the resulting tare. By pressing this key during 3s., the instrument will set the tare value to zero, and the TARE led will stop light up, indicating the GROSS value.

tArE 2

In this mode, the  key has no effect. The tare value is now introduced manually, being however the instrument operation the same as in the previous mode. The edit menu Hill will be accessed from the "RUN" mode, by pressing on the  key during 3s. Following the diagram.

tArE 3

In this mode, a variable, that we will call net value will be edited, acceding now also from "RUN", after pressing on  during 3 s following the diagram. The tare action, as in the first case, will have no effect until we press on the  key, being the instrument in "RUN" mode, the Led TARE will be then activated. The value stored in tare is now the difference between the value measured by the instrument when the tare action occurred and the net value. The value resulting from the difference between the measured value and the tare value will be the same. It will be necessary to enter in the programming menu and pass by "CndSP" > "ModtA" to reset the tare.

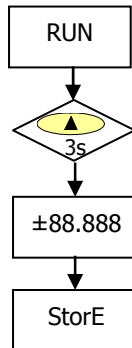

Example:

A process using a liquid contained in a tank from which are known according to the manufacturer specifications the gross weight, 100 Kg, and the net weight 75 Kg. In the weighing process is used a load cell connected to a AN 1500 M instrument and we need to know the liquid net weigh in each instant of the process. By selecting this tare mode, the net value would be introduced via edition following the enclosed diagram. When the instrument is measuring the tank, totally full of liquid, this would be 100 Kg, the instrument is tared, indicating then 75 Kg. and the quantity of remaining liquid in the tank while it is getting emptied.

5. KEYBOARD AND CONNECTOR FUNCTIONS

5.1 – Keyboard functions

Several functions can be controlled via keyboard that will produce different actions depending on the instrument operating mode:

Mode -RUN-:

TAREA and RESET TARA functions

Explained in the previous paragraph.

MAX/MIN function

Activated after pressing on the  key. From the normal reading mode, a press shows the maximum value read by the instrument since the last time it has been switched on, unless a RESET MAX/MIN is done, the MAX led will light up. A second press shows the minimum value in the same conditions as before, with the consequent minimum indication through the MIN led. A third press bring the instrument back to the normal reading mode.

Function RESET MAX/MIN

Pressing continuously the  during 3s., while the instrument shows the peak value (MAX), will produce a reset of the value. Will reset the minimum value if the same action is done while the instrument shows the valley value (MIN).

ENTER 3s function (PROGRAMMING LOCKOUT)

In mode RUN if the ENTER key is pressed continuously during 3 seconds, the instrument will show the indication CodE, and following 0000, allowing the user to introduce the security code. If the code that has been introduced is wrong, the instrument will go back to RUN mode, if it is correct, it will allow the access to the security menu. See paragraph 6 Page 34.

ENTER function

One press on the  key will bring the instrument to the -Prog- mode.

In -Prog- mode:

KEY 3s (RETURN TO FACTORY PROGRAMMING)

Allows entering a code of access to the reset of the configuration parameters, this code is 74. When entering this code the instrument shows the LoAdIng dEFaULt ConFIGurAtIon legend, following StorE, which means that they have been stored in the non volatile memory of the instrument.

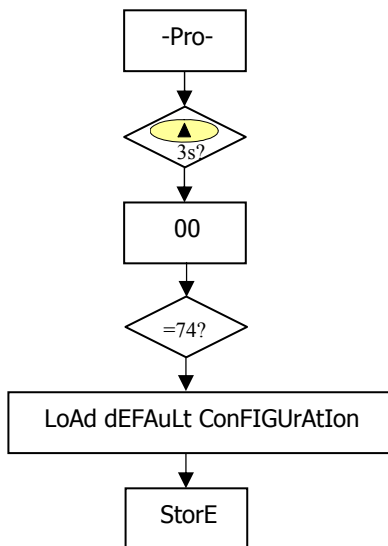

```
Factory configuration
INPUT: Process 0 - 10V
DISPLAY
  Input 1: +00.000  Display 1: +00.000
  Input 2: +10.000  Display 2: +10.000
  Filter P: 0
  Round 01
  Tare mode: 1
  Brightness: High
DISPLAY COLORS Run Mode: Green, Prog Mode.: Amber
SETPOINTS
  Setpoint 1: +01.000, Setpoint 2: +02.000
  Setpoint 3: +03.000, Setpoint 4: +04.000
  Compared with: Net
  Mode: HI
  Dly: 00.0
  Alarm Color: No Change
ANALOG OUTPUT CONFIGURATION
  Display HI: +10.000
  Display LO: +00.000
LOGIC FUNCTIONS PIN 2=function 1, PIN 3=function 2 and
PIN 4=function 6
```

DIRECT ACCESS TO SETPOINTS – KEY

Now, in case any of the **2RE**, **4RE**, **4OP**, **4OPP** options has been installed, the instrument allows a direct access to the programming of the setpoints value, pressing the  key sequentially for each one of the setpoints values available according the option installed.

5.2 – Connector functions

The connector CN3 provides 3 optocoupled inputs that can be operated from contacts logic levels supplied by an external electronic system. Three different functions may be then added to the functions available from the front panel keys. Each function is associated to a pin (PIN 2, PIN 3 y PIN 4) that is activated applying a low level, in each one, with respect to PIN 1 or COMMON. The association is achieved through the programming of a number between 0 and 15 corresponding to one of the functions listed in the following table.

- Factory configuration

As shipped from the factory, the CN3 connector allows the TARE, RESET TARE functions operated from the front-panel keyboard and moreover incorporates the HOLD function.

When a HOLD is made, the display value remains frozen while the corresponding pin is activated. The HOLD state, affects neither the instrument internal operation nor the analog and setpoint outputs.

CN3: FACTORY CONFIGURATION

| PIN (INPUT) | Function | Number |
|---------------|------------|---------------|
| PIN 1 | COMMON | |
| PIN 2 (INP-1) | TARE | Function nº 1 |
| PIN 3 (INP-2) | RESET TARE | Function nº 2 |
| PIN 4 (INP-3) | HOLD | Function nº 6 |

The external electronics (Fig. x) applied to the CN3 connector inputs must be capable of withstanding a potential of 40 V/ 20 mA present at all terminals with respect to COMMON. In order to guarantee the electromagnetic compatibility please refer to the connection instructions given on Page 9.

Logic functions diagram

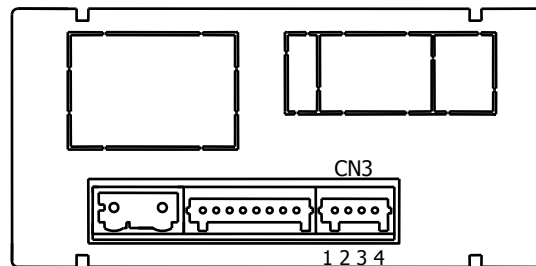
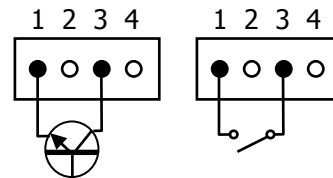

5.2.1 – Logic functions diagram

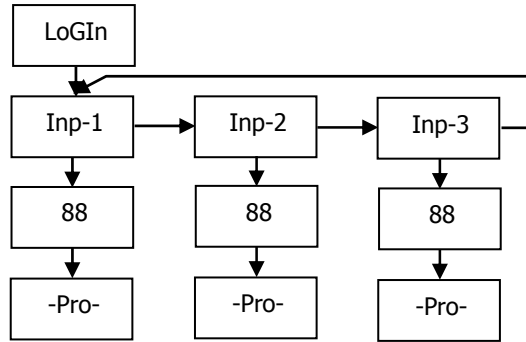

5.2.2 - Table of programmable functions

- Nº: Number to select the function by software.
- Function: Function name.
- Description: Description and characteristics of the function.
- Activation by:
Falling edge: the function is activated applying a falling edge to the corresponding pin with respect to common.
Low level: the function will remain activated as long as the corresponding pin is held at a low level.

| Nº | Function | Description | Activation by |
|----|-----------------|---|---------------|
| 0 | Deactivated | None | None |
| 1 | TARE * | Adds the current display value to the tare memory and sets the display to zero. | Falling edge |
| 2 | TARE RESET * | Adds the tare memory to the display value and clears the tare memory. | Falling edge |
| 3 | LIST RESET | Performs a reset of the peak or the valley, depending on selection. | Falling edge |
| 4 | SEE LIST | Displays peak value (MAX.), valley value (MIN.), tare value, net value (NET) or gross value (GROSS) depending on selection. | Low level |
| 5 | PRINT LIST | Sends to the printer depending on selection MAX., MIN, TARE, SET1, SET2, SET3 or SET4 value. | Falling edge |
| 6 | HOLD | Freezes the display while all the outputs remain active | Low level |
| 7 | BRIGHTNESS | Changes the display brightness from Hi to Low | Low level |
| 8 | DISPLAY COLOR | Changes display color (green, red or amber) | Low level |
| 9 | SETP PROG/TARE | Configures Setpoints or Tare depending on Selection List (TARE, SET1, SET2, SET3 and SET4) | Falling edge |
| 10 | FALSE SETPOINTS | Simulates that the instrument has a four Setpoints option installed | Low level |
| 11 | KEYB. EMULATION | Emulates keyboard (Input 1=ENTER, Input 2=SHIFT, Input 3=UP) | Low level |
| 12 | RESERVED | | |
| | | | |

* Only with mode TARE 1 and TARE 3

5.2.3 – Programming the functions

0 to 12

Once the user has acceded the menu of logic functions configuration, he can select, by pressing the  key, a function among those of the table.

Example: AN 1500 M with NET value of 1234.5

Message in Hexadecimal sent from the AN 1500 M RS4 output when logic function 5 is activated.

The chain of characters is: "#", "01", 0x0D, "NET: +1234.5", 0x0D

The AN 1500 M has to be programmed to work under protocol ASCII. See Page 47

Example ticket without date
using a panel printer

#01

NET: +1234.5

6. PROGRAMMING LOCK OUT BY SOFTWARE

The instrument is delivered with the programming locked out, giving access to all the programming levels. Once completed the instrument programming we recommend the following security measures be taken:

5. Lock out the programming access to prevent from programmed parameters modifications.
6. Lock out keyboard functions to prevent from accidental modifications.
7. There are two lockout modes: selective and total. If the parameters are going to be readjusted frequently, make a selective lockout. If no adjustment is going to be made, make a total lockout. Keyboard functions lockout is always possible.
8. The access to the lockout routine is allowed by entering a personalised code. We recommend changing the code set at factory and to write down your personalised code and keep it in a safe place.

TOTAL LOCKOUT

The access to the programming routines to read data is allowed even if all parameters are locked out totLC=1, but **it won't be possible to enter or modify data**. In this case, when entering in the programming mode, the display shows the indication "-dAtA-".

PARTIAL LOCKOUT

When only some parameters are locked out, all configuration data can be read but **only non protected parameters can be modified**. In such case, when entering in the programming mode, the display shows the indication "-Pro-".

Menus or submenus that can be locked out are:

- Setpoint 1 configuration (SEt 1).
- Setpoint 2 configuration (SEt 2).
- Setpoint 3 configuration (SEt 3).
- Setpoint 4 configuration (SEt 4).
- Input configuration (InPut).
- Display (diSP).
- Display color (CoLor).
- Setpoints value (SPVAL)
- Serial output (rSout) or Ethernet output (EtnEt) configuration
- Analog output configuration (Anout).
- Logic inputs configuration (LoGIn).
- Programming of the key TARE (tArE).
- Direct access to MAX. and MIN values (MAHMn).

The first four and "SEtVAL" only appear if the corresponding option 2RE, 4RE, 4OP ó 4OPP has been installed, "diSP", "FiltP" and "tArE" do not appear when the instruments configured for temperature measurement. "Anout" will appear when any of the NMA or NMV options are installed, "rSout" when any of the RS2 or RS4 and "EtnEt" for ETH output options are installed.

6.1 – Security menu diagram

The following figure shows the security menu. In this menu is configured the programming lockout. The access to this menu is accomplished from the run mode by pressing the  key during 3 seconds, until the "CodE" indication appears.

The instrument is shipped from factory with the following default code: "0000". Once entered this code, the "LIST" indication will appear, from which we will enter in the parameters lockout. Accessing to the "CHAnG" menu will allow us to enter a personal code, that we have to write down and keep in a safe place (**Do not count on your memory**). This personal code makes the default code useless.

If an incorrect code is entered, the instrument will return automatically to the run mode.

Total lockout programming is achieved changing to 1 the "totLC" variable, changing it to 0, will lead to the selective lockout of the programming variables. Programming each one of the parameters to 1 will activate the lockout, if they are set to 0 programming will be accessible. Though the programming is locked out, it remains possible to visualise the current programming.

The "StorE" indication informs that the modifications effectuated have been stored correctly.

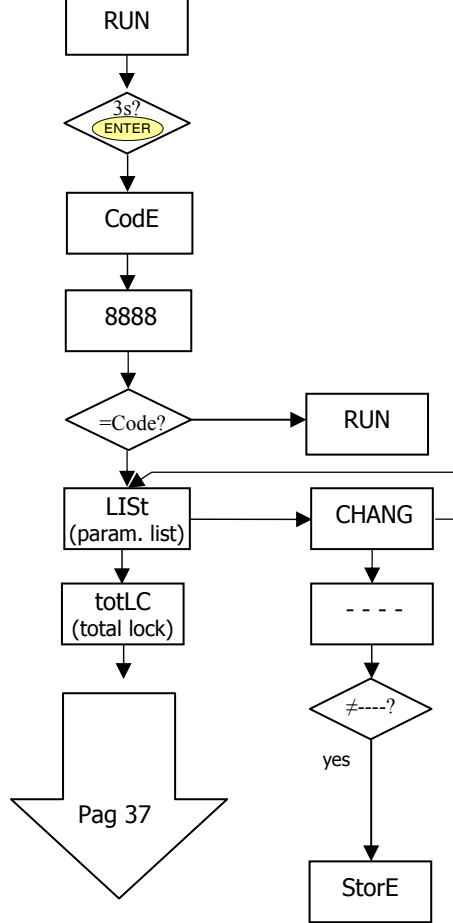

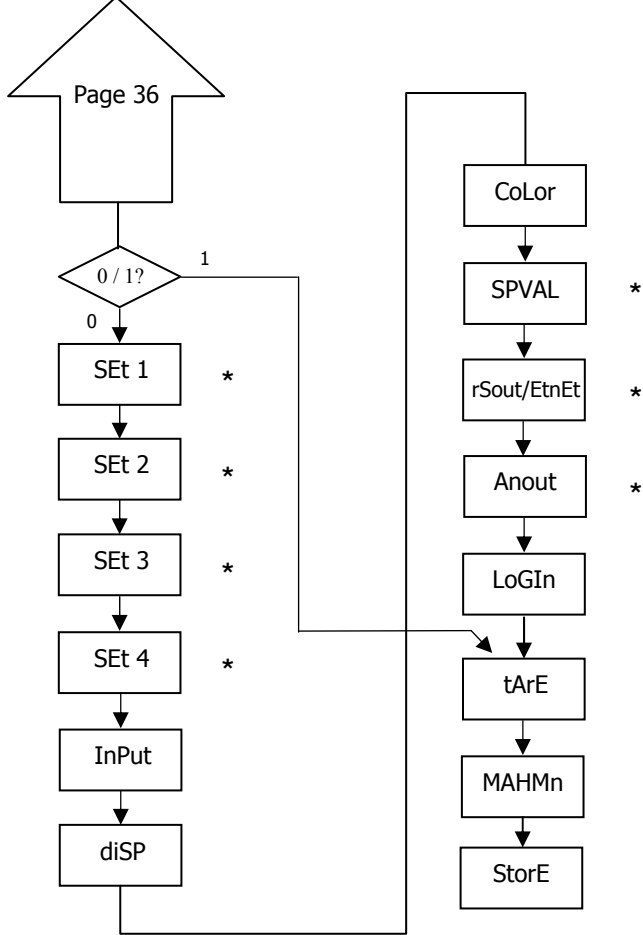

0 allows its programming
1 locks the access to programming
*** Only appear if the corresponding options have been installed**

7. OUTPUT OPTIONS

Optionally, model AN 1500 M can incorporate one or several output options for control or communication:

Communication options

| | |
|------------|---------------|
| RS2 | Serial RS232C |
| RS4 | Serial RS485 |
| ETH | Ethernet |

Control options

| | |
|-------------|------------------|
| NMA | Analog 4-20 mA |
| NMV | Analog 0-10 V |
| 2RE | 2 Relays SPDT 8A |
| 4RE | 4 Relays SPST 5A |
| 4OP | 4 NPN outputs |
| 4OPP | 4 PNP outputs |

All mentioned options are optoisolated with respect to input signal and power supply.

The output cards are easily installed on the meter's main board by means of plug-in connectors and each one activates its own programming modules that provides complete software configuration.

Additional capabilities of the unit with output options:

- Control and processing of limit values via ON/OFF logic outputs (2 relays, 4 relays, 4 NPN outputs or 4 PNP outputs) or proportional output (4-20mA, 0-10V).
- Communication, data transmission and remote programming via serial interface.

For more detailed information on characteristics and mounting, please refer to the specific manual supplied with each option.

The following figure shows the location of the different outputs options.

The **2RE**, **4RE**, **4OP** y **4OPP** options are alternative and only one of them can be placed into the connector M1.

The **RS2**, **RS4** and **ETH** options are also alternative and only one of them can be placed into the connector M2

The **NMA** or **NMV** option is placed into the connector M3.

Up to three output options can be present at the same time and operate simultaneously:

- One analog (ref. **NMA** or ref **NMV**)
- One RS232C (ref. **RS2**), RS485 (ref. **RS4**) or Ethernet (ref. **ETH**).
- One 2 relays (ref. **2RE**) or 4 relays (ref. **4RE**) or 4 NPN (ref. **4OP**) or 4 PNP (ref. **4OPP**) outputs.

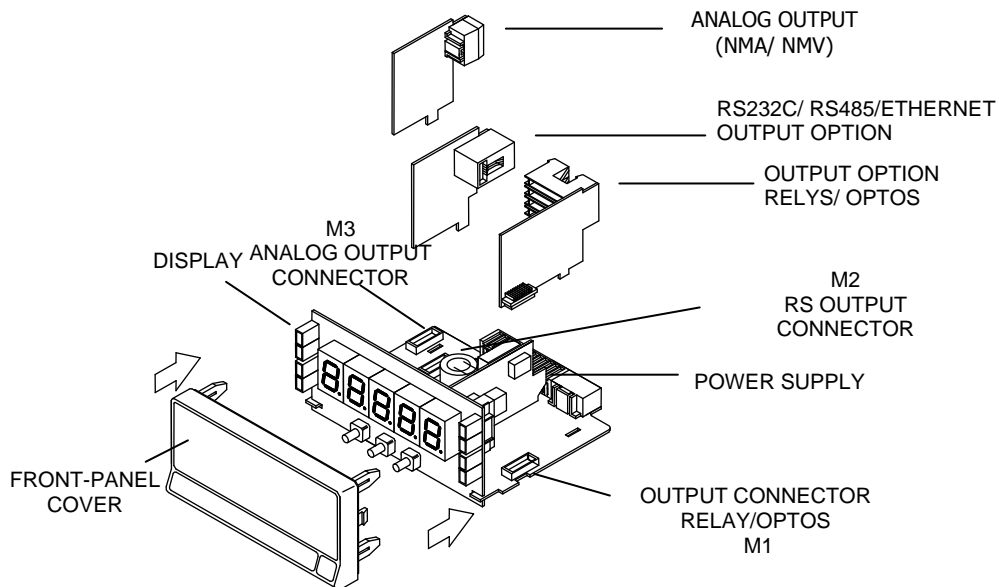

7.1 –SETPOINTS OUTPUT

7.1.1 – Introduction

An option of 2 or 4 SETPOINTS, programmable within the full display range, can be incorporated to the unit thus providing alarm and control capabilities by means of individual LED indicators and relay or transistor outputs. All the setpoints provide independently programmable value, time delay (in seconds), asymmetrical or symmetrical hysteresis (in counts of display) and selectable HI/LO acting.

The setpoint option consists of a plug-in additional card that once installed to the meter's main board, activates its own programming module, they are totally configurable by the user and their access can be locked out via software.

These are the control output options available:

2RE: 2 Relays SPDT 8A

4RE: 4 Relays SPST 5A

4OP: 4 NPN outputs

4OPP: 4 PNP outputs

These types of outputs, capable of carrying out a wide variety of control operations and processing of limit values, increases notably the unit's performance qualities thanks to the possibility of combining basic alarm functions with advanced safety and control applications.

As programmed like independent setpoints, the alarm outputs activate when the display value reaches the user-programmed value. The independent alarms programming requires definition of the following basic parameters:

a. COMPARISON NET/ GROSS

In "NET" mode will compare the setpoint value with the display net value. In "GROSS" mode, the comparison will be with the sum net + tare.

b. HI/ LO ACTING MODE.

In HI mode, the output activates when the display value exceeds the setpoint level and in LO mode, the output activates when the display value falls below the setpoint

c. RELAYS CONTACT DEFAULT STATE NO/NC.

Defines relays contact status by default: "NO" (normal open) or "NC" (normally closed). NC status can be used as a **FAIL SAFE** function, allowing the power supply or device failure detection sending a signal informing to the PLC or main monitoring system.

d. PROGRAMMABLE TIME DELAY or HYSTERESIS.

Each output action can be deferred by a programmable time delay or hysteresis level.

The time delay is the time that takes the output to activate after passing through the setpoint in the up or down direction, while the hysteresis band will be selected asymmetrical i.e. only acts on the output deactivation edge.

The delay is programmable in seconds, from 0 to 99.

The hysteresis can be programmed, in counts, within the full display range. The decimal point appears in the same position as programmed in the display configuration module.

The figures 1 and 2 show the time delay action (dly) and the asymmetrical hysteresis action (hys-1) of two alarms (SET1 and SET2) programmed to activate in HI mode (OUT1) and LO mode (OUT2)

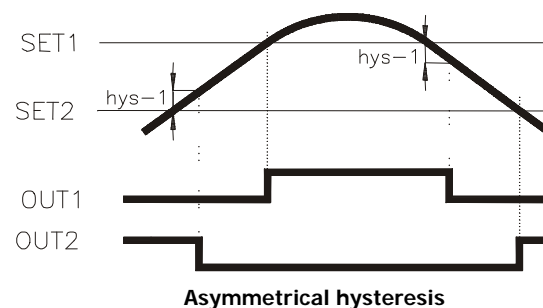
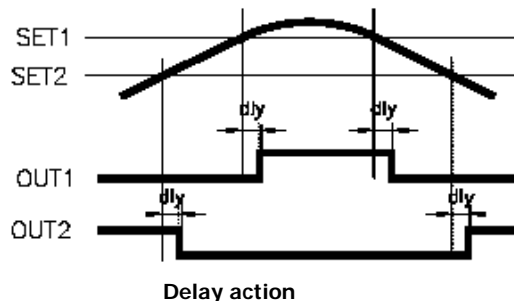

7.1.3 – Installation

Lift out the electronics assembly from the case and use a screw-driver to push on the junctions between the case and the shadow areas to detach them from the case. See fig. The so performed orifice will allow any of the setpoints (2RE, 4RE, 4OP or 4OPP) board output connectors be brought out at the rear of the instrument. The option is installed by plugging the connector in the main board location. Insert the card pin in the corresponding main board slot and push down to attach both connectors.

If the instrument is to be installed in high vibrating environments, it is recommended to solder the card to the main board making use of the copper tracks on both sides of the card pin and around the main board hole on its solder side.

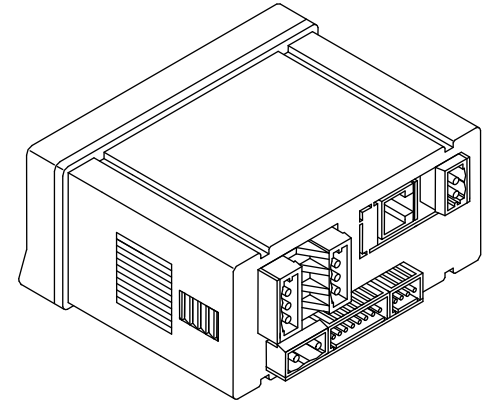

7.1.4 – Wiring

2RE - 2 RELAYS OPTION

PIN 4 = NO2 PIN 1 = NO1
 PIN 5 = COMM2 PIN 2 = COMM1
 PIN 6 = NC2 PIN 3 = NC1

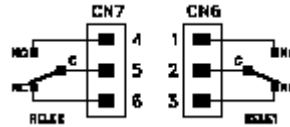

4OP - 4 OPTOS NPN OPTION

PIN 4 = OP4 PIN 1 = OP1
 PIN 5 = N/C PIN 2 = OP2
 PIN 6 = COMM PIN 3 = OP3

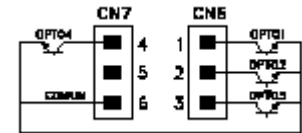

4RE - 4 RELAYS OPTION

PIN 4 = RL4 PIN 1 = RL1
 PIN 5 = N/C PIN 2 = RL2
 PIN 6 = COMM PIN 3 = RL3

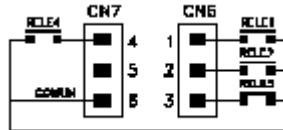

4OPP - 4 OPTOS PNP OPTION

PIN 4 = OP4 PIN 1 = OP1
 PIN 5 = N/C PIN 2 = OP2
 PIN 6 = COMM PIN 3 = OP3

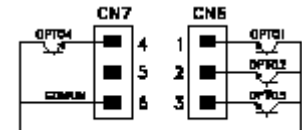

Each output card is supplied with an adhesive label that indicates the wiring connections of each option. To help identifying each terminal, this label should be placed in the lower side of the meter case, beside the basic functions label.

NOTE: In case that the outputs are used to drive inductive loads, it is recommended to add an RC network between the coil terminals (preferably) or between the relay contacts to limit electromagnetic effects.

7.1.5 – technical specifications

| CHARACTERISTICS | 2RE OPTION | 4RE OPTION |
|-----------------------------------|-------------------------|-------------------------|
| MAX.CURRENT(RESISTIVE LOAD) | 8 A | 5 A |
| MAX.POWER | 2000 VA / 192 W | 1250 VA / 150 W |
| MAX.VOLTAGE..... | 250 VAC / 150 VDC | 277 VAC / 125 VDC |
| CONTACT RESISTANCE..... | Max. 3mΩ | Max. 30mΩ |
| SWITCHING TIME | Max. 10ms | Máx. 10ms |

4OP and 4OPP OPTION

| | |
|-----------------------|---------------|
| MAX VOLTAGE | 50 VDC |
| MAX CURRENT | 50 mA |
| LEAKAGE CURRENT | 100 μA (max.) |
| SWITCHING TIME | 1 ms (max.) |

7.1.6 Setpoints menu diagram

The complete programming of one of the setpoints is showed here, it is valid for the rest of the setpoints.

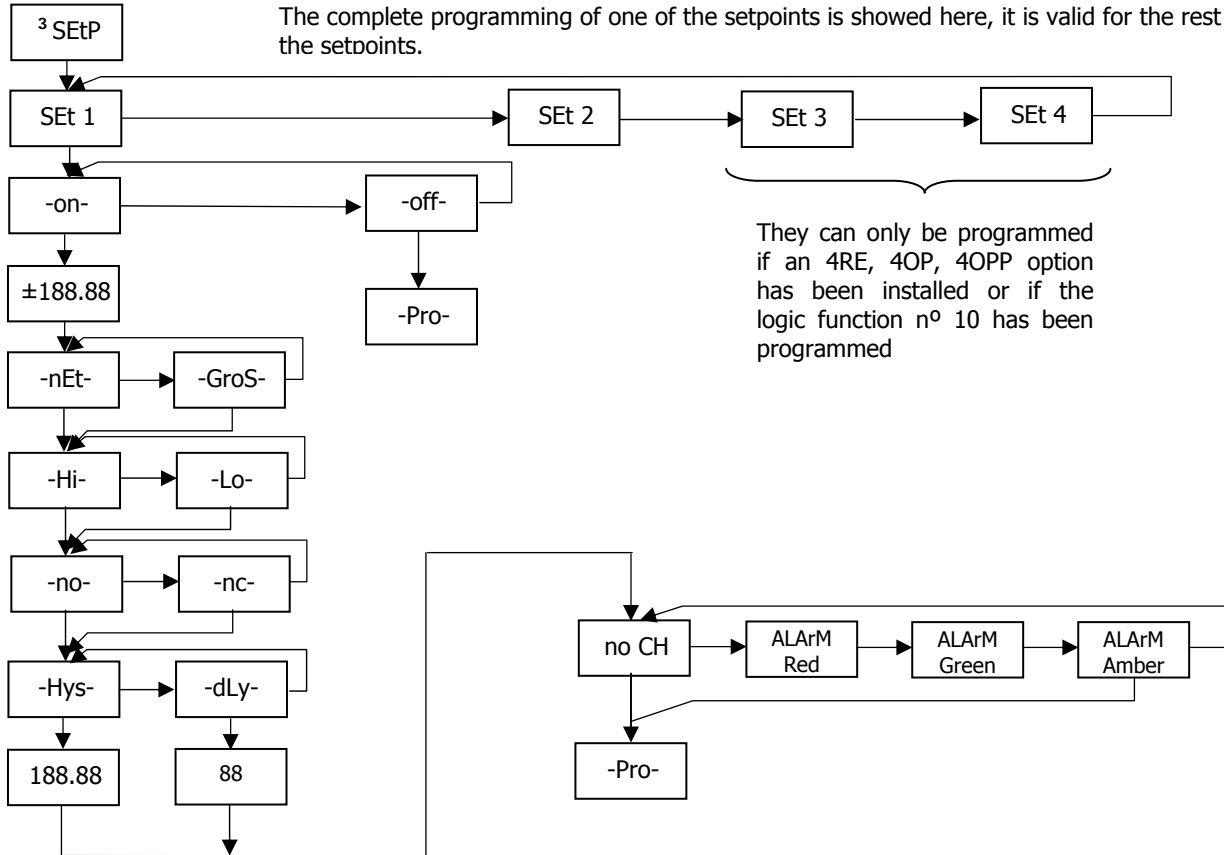

They can only be programmed if an 4RE, 4OP, 4OPP option has been installed or if the logic function n° 10 has been programmed

7.1.7 – Direct access to the setpoints value programming

If any of the options corresponding to the setpoints has been installed, it is possible to accede directly to the setpoints value without need to go through the programming menu just by pressing the  key in PROG mode, as shown in diagram below, supposing that the card installed are 4RE, 4OP or 4OPP, if it is the 2RE card only Set1 y Set2 would appear. **Setpoints configured at "off" do not appear on the list".**

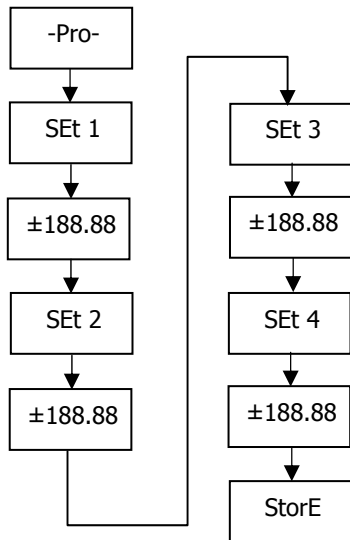

Remember that the decimal point position comes determined by what has been programmed in the SCAL menu.

7.2.1 – Introduction

The RS232C output option consists of an additional card (reference **RS2**) that is installed in the M2 plug-in connector of the instrument's main board. The card incorporates one 4 wires telephone socket with output at the the rear of the instrument.

The RS485 output option consists of an additional card (reference **RS4** that is also installed in the M2 plug-in connector of the instrument's main board. The card incorporates a 6-pin / 4-contact telephone socked with output at the rear of the meter.

The serial output permits to construct a communication line through which a master device can request the transmission of data such de display value, setpoint values, peak, valley, tare (or offset in case of thermometers) and to perform operations such as tare of the display, reset of the peak, valley or tare memories and update setpoint values..

The output option is totally software configurable as for the transmission rate (1200, 2400, 4800, 9600 ó 19200 Baud), the instrument's address (from 00 to 99), the protocol (ASCII, ISO 1745 and MODBUS RTU).

The operating mode is half-duplex and it normally stands in data reception mode until reception of a message.

A valid data transmission may cause the immediate execution of an action (tare, reset of peak, valley or tare memories modification of setpoint values) or the transmission of a response from the instrument (display value, one of the setpoints value, peak, valley, tare / offset). Only the display value can be called up via external contact according diagram in page 9 of RS2 manual.

Three communication modes are available; the ASCII mode uses a simple protocol compatible with several DITEL instruments. The ISO mode, in accordance with the ISO 1745 norm, allows a more effective communication in noisy environments as it checks the messages validity checking both transmission and reception. And eventually the protocol MODBUS RTU

As you will see in the functions table, the protocol ASCII uses 1 or 2 bytes according to the command type and the protocol ISO 1745 imposes the use of two bytes per command.

7.2. 2 – RS output menu diagram

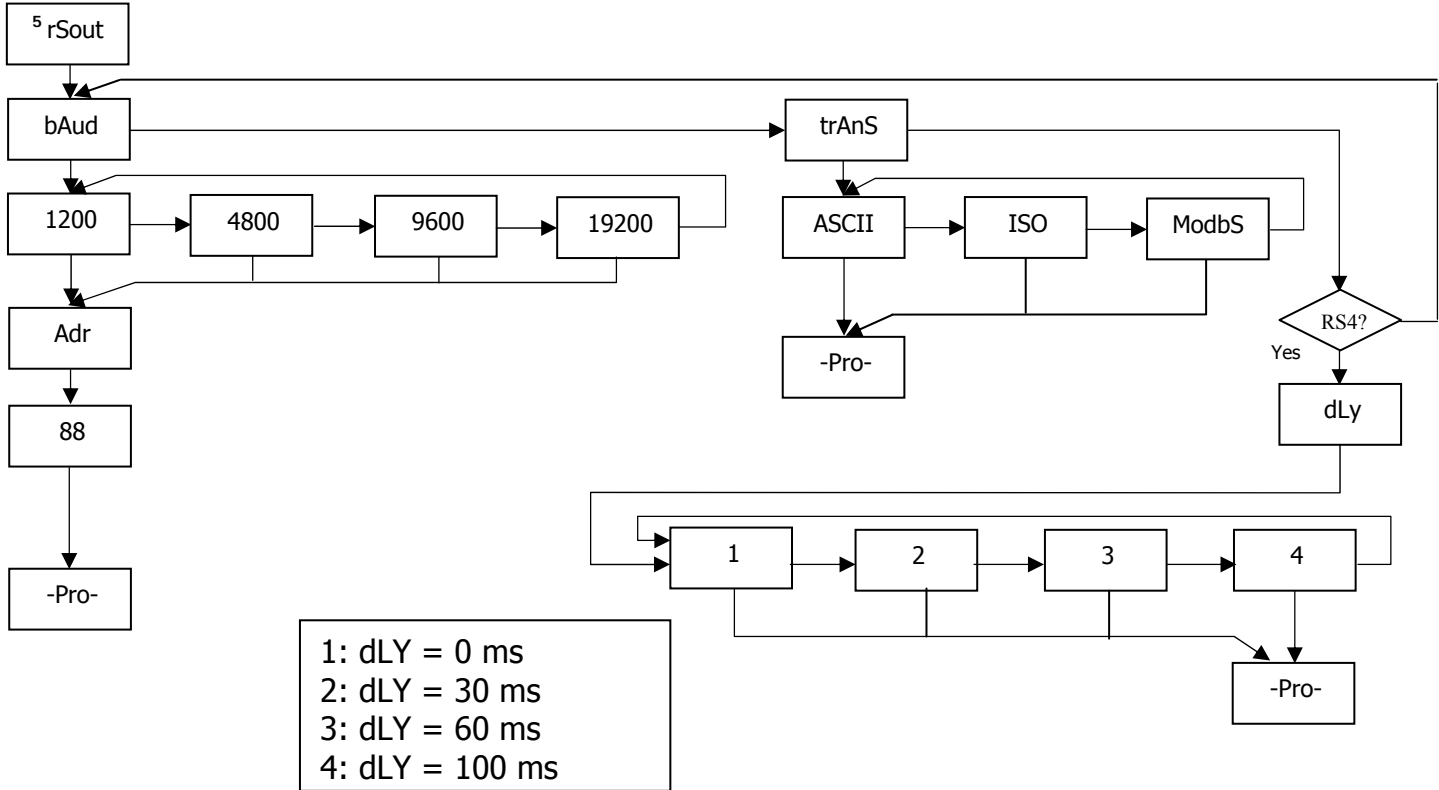

ASCII PROTOCOL

The Transmission format is: 1 START bit, 8 DATA bits, NO parity bit and 1 STOP bit.

- MESSAGE FORMAT TO BE SENT

A message sent to the instrument must be composed of the following sequence of ASCII characters:

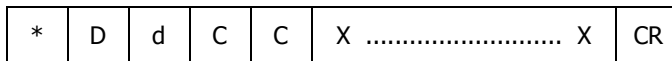

One " * " byte [ASCII 42] of start of message.

Two address bytes (from 00 to 99).

One or two ASCII characters corresponding to the desired command according to the functions table (List of commands).

In case that the command request for a modification of parameters, the new value shall be transmitted with one byte of sign (+ [ASCII 43] or - [ASCII 45]) followed by a block of N ASCII characters (depending on model), including the decimal point.

One " CR " [ASCII 13] character of end of message. CR= Carriage Return

- MESSAGE FORMAT FROM INSTRUMENT

The data sent from the instrument as a response to a data request type command from the master device is the following:

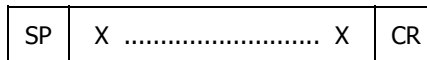

One byte of blank space [ASCII 32].

One text (requested values) consisting of a byte of sign (+ [ASCII 43] or - [ASCII 45]) followed by a block of N ASCII characters (depending on model) including the decimal point.

One " CR " byte [ASCII 13] of end of message.

If the command belongs to "orders" or "changing parameters", the instruments gives no response.

ISO 1745 PROTOCOL

The transmission format is: 1 START bit, 7 DATA bits, 1 EVEN PARITY bit and 1 STOP bit.

- MESSAGE FORMAT TO BE SENT

The message format, as sent from the master device, must consist of the following sequence of characters:

| | | | | | | | | |
|-----|---|---|-----|---|---|-----------|-----|-----|
| SOH | D | d | STX | C | C | X X | ETX | BCC |
|-----|---|---|-----|---|---|-----------|-----|-----|

One byte SOH of start of message [ASCII 01].

Two bytes corresponding the first to the tens and the second to the units of the instrument address number.

One byte STX of start of text [ASCII 02].

Two commands bytes according to the functions table.

In case of commands that change parameters, a block of N bytes corresponding to the new value including sign and decimal point.

One byte ETX of end of text [ASCII 03].

One control byte BCC calculated in the following manner:

Perform an exclusive-OR with all bytes between the STX (not included) and the ETX (included).

- If the obtained byte (in ASCII format) is higher than 32, it can be taken as the BCC.
- If the obtained byte (in ASCII format) is lower than 32, the BCC byte will be obtained by adding 32.

- MESSAGE FORMAT FROM INSTRUMENT

The format of a message as sent from the instrument in response to a command from the master device is the following:

1. In case of commands that ask for transmission of a value (data request type):

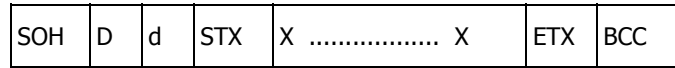

One byte SOH of start of message [ASCII 01].

Two address bytes.

One byte STX of start of text [ASCII 02].

N bytes corresponding to the requested value (including the sign and decimal point).

One byte ETX of end of text [ASCII 03].

One control byte BCC calculated with the method described in page 49.

2. In case of commands that do not imply the return of a value (command type or changing parameter):

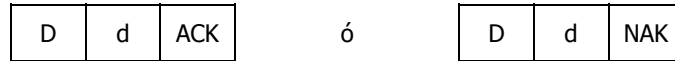

The instrument sends a confirmation when it receives a message.

If the message has been correctly received and interpreted, the response will consist of two address bytes and one "ACK" [ASCII 06]

If the received message has not been well interpreted or it has been detected as to have errors, the response will be two address bytes and a "NAK" [ASCII 21].

REQUEST OF DATA

| ASCII | ISO | Information |
|-------|-----|---|
| P | 0P | Peak value |
| V | 0V | Valley value |
| T | 0T | Tare or offset value |
| D | 0D | Display value |
| I | 0I | Alarm "status" byte |
| L1 | L1 | Setpoint 1 value |
| L2 | L2 | Setpoint 2 value |
| L3 | L3 | Setpoint 3 value |
| L4 | L4 | Setpoint 4 value |
| | NB | Cards installed |
| | | Returns: |
| | | - "04": RS2 |
| | | - "05": RS2, 2RE |
| | | - "06": RS2, 4OP |
| | | - "08": RS4 |
| | | - "09": RS4, 2RE |
| | | - "0:": RS4, 4 Setpoints(4RE, 4OP ó 4OPP) |
| | | - "44": NMA or NMV, RS2 |
| | | - "45": NMA or NMV, RS2, 2RE |
| | | - "46": NMA or NMV, RS2, 4 Setpoints(4RE, 4OP ó 4OPP) |
| | | - "48": NMA or NMV, RS4 |
| | | - "49": NMA or NMV, RS4, 2RE |
| | | - "4:": NMA or NMV, RS4, 4 Setpoints(4RE, 4OP ó 4OPP) |
| TT | | Model + Version |

MODIFICATION OF DATA

| ASCII | ISO | Parameter |
|-------|-----|--|
| M1 | M1 | Change the setpoint1 value in memory |
| M2 | M2 | Change the setpoint2 value in memory |
| M3 | M3 | Change the setpoint3 value in memory |
| M4 | M4 | Change the setpoint4 value in memory |
| b1 | b1 | Change brightness to "Hi" level without saving in memory |
| b2 | b2 | Change brightness to "Lo" level without saving in memory |
| c1 | c1 | Change display color to amber without saving in memory |
| c2 | c2 | Change display color to green without saving in memory |
| c3 | c3 | Change display color to red without saving in memory |

COMMANDS

| ASCII | ISO | Command |
|-------|-----|------------------|
| p | 0p | Peak reset |
| v | 0v | Valley reset |
| r | 0r | Tare reset |
| t | 0t | Tare the display |

7.3 ANALOG OUTPUT

7.3.1 – Introduction

Two ranges of analog output (0-10 V y 4-20 mA) can be incorporated to the AN 1500 M by means of an additional card, either the NMV card for voltage output or the NMA card for current output, which is installed on the meter's main board via plug-in connector M3, both cards, cannot be used simultaneously.

The outputs are opto-isolated with respect to the signal input and the power supply.

The optional board provides a two terminal connector [(+) and (-)] that drives out a signal variation from 0 to 10V or from 4mA to 20mA proportional to a user-defined display range.

This way, the meter is furnished with a signal that can be used to control variables and operates at each moment proportionally to the magnitude of the effect under control.

These signals can also be used to transmit display information to a variety of terminal equipment such as graphic recorders, controllers, remote displays or other devices that accept input data in analog form.

The instrument will detect the type of option that has been installed and will operate in accordance.

The display values producing the full scale output (OUT-HI and OUT-LO) are also introduced via front-panel buttons in the same programming module. The analog output then follows the display variation between the HI and LO programmed points.

The output signal can be set up for reverse action by programming the low display for the high output (OUT-HI) and the high display for the low output (OUT-LO).

In case of 'display overflow', 'sensorbreak' or 'input error', the output signal (V or mA) can be configured to be fixed at a high level 'Hi' or a low level 'Lo'.

7.3.2 – Installation of NMA or NMV option

Lift out the electronics assembly from the case and use a screwdriver to pull on the junctions between the case and the grey-marked area to detach it from the case. The so performed orifice will allow the analog output board connector be brought out at the rear of the instrument. Install the circuit board so that the lower pin fits into the corresponding main board insertion slot and push down to plug the M3 option connector in the main board M3 location. If the instrument is to be installed in high vibrating environments, it is recommended to solder the card to the main board making use of the copper tracks on both sides of the card pin and around the main board hole on its solder side.

7.3.3 – Connection

Each output card is supplied with an adhesive label that indicates the wiring connections of each option (see fig.). To help identifying each terminal, this label should be placed in the lower side of the meter case, beside the basic functions label.

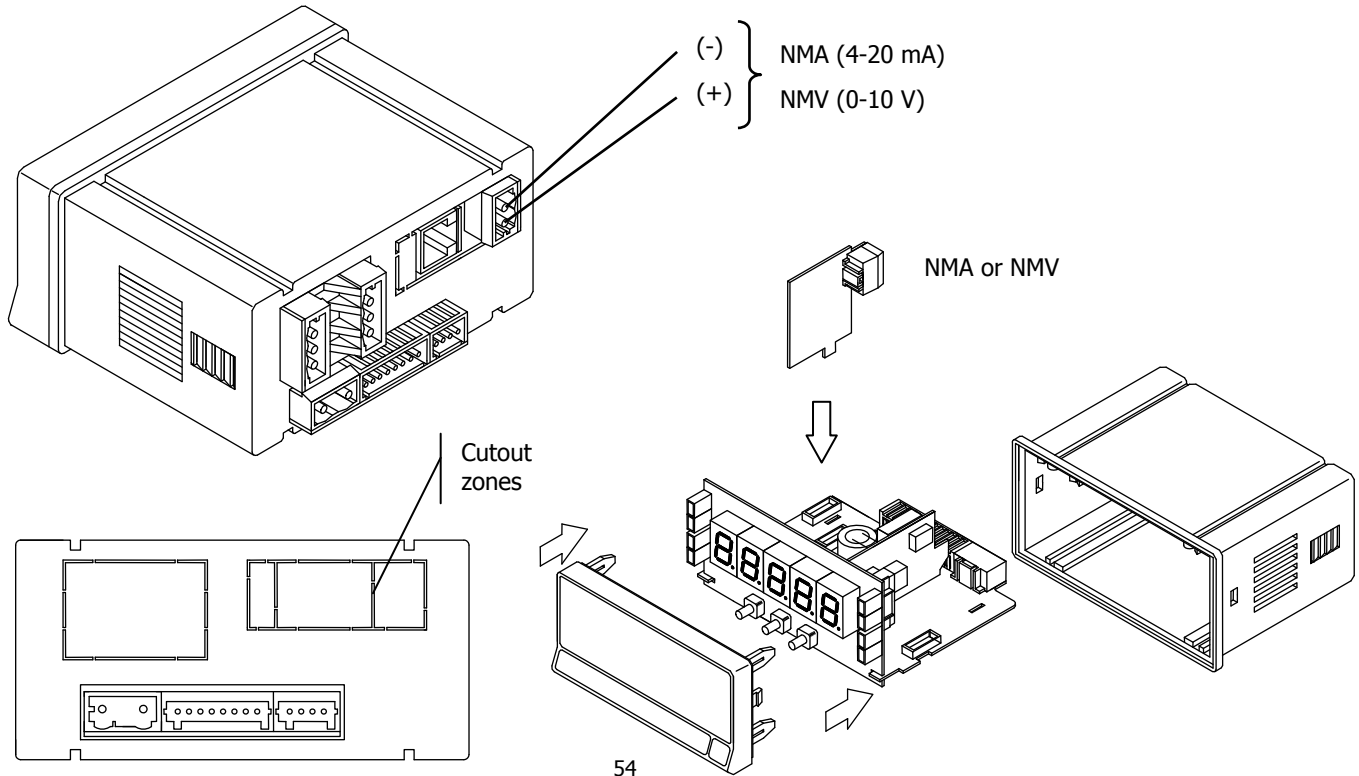

7.3.4 – Technical specifications

| CHARACTERISTICS | NMA OUTPUT | NMV OUTPUT |
|---------------------|--|---------------------------|
| RESOLUTION | 13 BITS..... | 13 BITS |
| ACCURACY | 0.1% F.S. ±1BIT..... | 0.1% F.S. ±1BIT |
| RESPONSE TIME | 10 ms..... | 10 ms |
| THERMAL DRIFT | 0.5 $\mu\text{A}/^\circ\text{C}$ | 0.2 mV/ $^\circ\text{C}$ |
| MAXIMUM LOAD..... | $\leq 500 \Omega$ | $\geq 10 \text{ K}\Omega$ |

7.3.5 – Analog output menu diagram

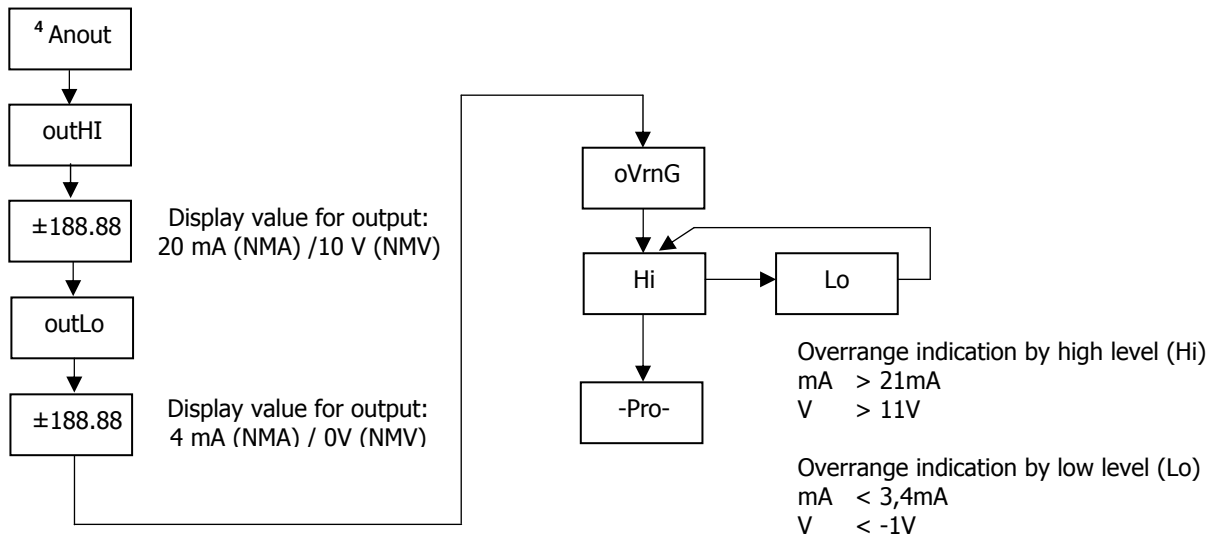



The instruments are warranted against defective materials and workmanship for a period of three years from date of delivery.

If a product appears to have a defect or fails during the normal use within the warranty period, please contact the distributor from which you purchased the product.

This warranty does not apply to defects resulting from action of the buyer such as mishandling or improper interfacing.

The liability under this warranty shall extend only to the repair of the instrument. No responsibility is assumed by the manufacturer for any damage which may result from its use.

TECHNICAL SPECIFICATIONS

INPUT SIGNAL

- Configuration.....asymmetric differential

Process input Voltage Current

- Voltage ± 10 V DC ± 20 mA DC
- Max. resolution 1 mV 1 μ A
- Input impedance 1 M Ω 15 Ω
- Excitation 24 V @ 60 mA, 10/ 5 V @ 60 mA
- Max. error \pm (0.1% of the reading +1 digit)

Load cell input

- Voltage ± 15 mV \pm 30mV \pm 150mV
- Max. resolution 1 μ V
- Input impedance 100 M Ω
- Excitation 10/ 5V @ 60 mA
- Max. error \pm (0.1% of the reading +1 digit)

Potentiometer input

- Voltage ± 10 V DC
- Input impedance 1 M Ω
- Display resolution 0.001%
- Max. error \pm (0.1% of the reading +1 digit)
- Potentiometer minimum value 200 Ω

Temperature input

- Cold junction compensation.....-10 $^{\circ}$ C to +60 $^{\circ}$ C
- Cold junction \pm (0.05 $^{\circ}$ C/ $^{\circ}$ C +0.1 $^{\circ}$ C)
- Pt100 sensor excitation < 1 mA DC
- Max. Lead resistance 40 Ω / cable (balanced)

| Input | Range (res. 0.1 $^{\circ}$) | Accuracy (res. 0.1 $^{\circ}$) | Range (res. 1 $^{\circ}$) | Accuracy (res. 1 $^{\circ}$) |
|-------|-----------------------------------|------------------------------------|-------------------------------|----------------------------------|
| TC J | -150,0 to +1100,0 $^{\circ}$ C | 0.4% rdg \pm 0.6 $^{\circ}$ C | -150 to +1100 $^{\circ}$ C | 0.4% rdg \pm 1 $^{\circ}$ C |
| | -238,0 to +2012,0 $^{\circ}$ F | 0.4% rdg \pm 1 $^{\circ}$ F | -238 to +2012 $^{\circ}$ F | 0.4% rdg \pm 2 $^{\circ}$ F |
| TC K | -150,0 to +1200,0 $^{\circ}$ C | 0.4% rdg \pm 0.6 $^{\circ}$ C | -150 to +1200 $^{\circ}$ C | 0.4% rdg \pm 1 $^{\circ}$ C |
| | -238,0 to +2192,0 $^{\circ}$ F | 0.4% rdg \pm 1 $^{\circ}$ F | -238 to +2192 $^{\circ}$ F | 0.4% rdg \pm 2 $^{\circ}$ F |
| TC T | -200,0 to +400,0 $^{\circ}$ C | 0.4% rdg \pm 0.6 $^{\circ}$ C | -200 to +400 $^{\circ}$ C | 0.4% rdg \pm 1 $^{\circ}$ C |
| | -328,0 to +752,0 $^{\circ}$ F | 0.4% rdg \pm 1 $^{\circ}$ F | -328 to +752 $^{\circ}$ F | 0.4% rdg \pm 2 $^{\circ}$ F |
| TC N | -150,0 to +1300,0 $^{\circ}$ C | 0.4% rdg \pm 0.6 $^{\circ}$ C | -150 to +1300 $^{\circ}$ C | 0.4% rdg \pm 1 $^{\circ}$ C |
| | -238,0 to +2372,0 $^{\circ}$ F | 0.4% rdg \pm 1 $^{\circ}$ F | -238 to +2372 $^{\circ}$ F | 0.4% rdg \pm 2 $^{\circ}$ F |
| Pt100 | -200,0 to +800,0 $^{\circ}$ C | 0.2% rdg \pm 0.6 $^{\circ}$ C | -200 to +800 $^{\circ}$ C | 0.2% rdg \pm 1 $^{\circ}$ C |
| | -328,0 to +1472,0 $^{\circ}$ F | 0.2% rdg \pm 1 $^{\circ}$ F | -328 to +1472 $^{\circ}$ F | 0.2% rdg \pm 2 $^{\circ}$ F |

MAX input signal applicable

- Process mA ± 22 mA
- Process V ± 11 V
- Load cell
 - ± 15 mV..... ± 16.5 mV
 - ± 30 mV..... ± 33 mV
 - ± 150 mV..... ± 165 mV

MAX. continuous overload V and mV inputs..... 50 V

MAX. continuous overload mA inputs 50 mA

DISPLAY

- Principal -19999/ 39999, 5 digits tricolor 14 mm
- Decimal point programmable
- LEDs 4 for functions and 4 for outputs
- Display update rate
 - Process/ Load cell 20/ s
 - Pt100 20/ s
 - Thermocouple 10/ s
- Input overrange, display *-oUER, oUEr*

CONVERSION

- Technique Sigma/ Delta
- Resolution (± 15 bit)
- Rate 20/s

- temperature coefficient 100 ppm/ °C
- Warm-up time 15 minutes

POWER SUPPLY

- AN 1500 M 85 VAC – 265 VAC / 100 VDC – 300 VDC
- AN 1500 M6 22 VAC – 53 VAC / 10,5 VDC – 70 VDC

FUSES (DIN 41661) – Not included

- AN 1500 M (230/115V AC) F 0.5 A / 250 V
- AN 1500 M6 (24/48V AC) F 2 A / 250 V

OPEN CIRCUIT OR SHORTCIRCUIT ERROR

- Pt100, TC, Load cell (open) " - - - - "
- Load cell, mA (short) " - - - - "

ZERO INPUT ERROR ('InErr'=Yes)

- Process indication, load cell " - - - - "
- Input signal limits $\pm 0.1\%$ FS

FILTERS

Filter P

- Cut-off frequency 4Hz to 0.05Hz
- Slope 20 dB/decade

ENVIRONMENTAL

- Indoor use
- Operating temperature -10 °C to +60 °C
- Storage temperature -25 °C to +85 °C
- Relative humidity non-condensed <95 % to 40 °C
- Max. altitude 2000 meters

DIMENSIONS

- Dimensions 96x48x60 mm
- Panel cutout 92x45 mm
- Weight 135 g
- Case material polycarbonate s/UL 94 V-0
- Sealed front panel IP65

